

## Copyright

This documentation and the software included with this product are copyrighted 2001 by Advantech Co., Ltd. All rights are reserved. Advantech Co., Ltd. reserves the right to make improvements in the products described in this manual at any time without notice. No part of this manual may be reproduced, copied, translated or transmitted in any form or by any means without the prior written permission of Advantech Co., Ltd. Information provided in this manual is intended to be accurate and reliable. However, Advantech Co., Ltd. assumes no responsibility for its use, nor for any infringements of the rights of third parties which may result from its use.

## Acknowledgments

PC-LabCard is a trademark of Advantech Co., Ltd. IBM and PC are trademarks of International Business Machines Corporation. MS-DOS, Windows, Microsoft Visual C++ and Visual BASIC are trademarks of Microsoft Corporation. Intel and Pentium are trademarks of Intel Corporation. Delphi and C++ Builder are trademarks of Inprise Corporation.

## CE notification

The PCI-1761, developed by ADVANTECH CO., LTD., has passed the CE test for environmental specifications when shielded cables are used for external wiring. We recommend the use of shielded cables. This kind of cable is available from Advantech. Please contact your local supplier for ordering information.

## On-line Technical Support

For technical support and service, please visit our support website

---

### Note:

 Concerning saving the environment, we'd like to reduce the paper used for the user's manuals. Starting with *Appendix C*, please find the PDF file on the CD-ROM.

---



# Contents

<b>Chapter 1 Introduction .....</b>	<b>1</b>
1.1 Features .....	1
1.2 Applications .....	3
1.3 Installation Guide .....	3
1.4 Software Overview.....	5
1.5 DLL Driver Programming Roadmap .....	6
1.6 Accessories .....	8
<b>Chapter 2 Installation.....</b>	<b>9</b>
2.1 Unpacking .....	9
2.2 Switch and Jumper Settings .....	11
2.3 I/O connectors .....	12
2.4 Driver Installation .....	13
2.5 Hardware Installation .....	15
2.6 Device Setup & Configuration .....	17
<b>Chapter 3 Signal Connections .....</b>	<b>21</b>
3.1 Overview .....	21
3.2 Isolated Digital Input Connections.....	21
3.3 Relay connections .....	22
<b>Appendix A Specifications .....</b>	<b>23</b>
<b>Appendix B Block diagram.....</b>	<b>25</b>
<b>Appendix C Register Structure and Format.....</b>	<b>26</b>
C.1 Overview .....	26
C.2 I/O Port Address Map.....	26
C.3 Relay I/O Registers - BASE+0H .....	28
C.4 Isolated Digital Input Registers - BASE+1H .....	29
C.5 Board ID - BASE+2H.....	29
C.6 Interrupt Status Register - BASE+3H/4H/5H .....	30
C.7 Interrupt Control Register - BASE+3H/4H/5H.....	31



# Chapter 1 Introduction

---

Thank you for buying the Advantech PCI-1761. The Advantech PCI-1761 is a 8-channel relay actuator and 8-channel isolated digital input card for the PCI bus.

Its eight on-board SPDT relays are ideal for applications such as device ON/OFF control or small power switched. For easy monitoring, each relay is equipped with one red LED to show its ON/OFF status.

The PCI-1761's eight optically-isolated digital input channels are ideal for digital input in noisy environments or with floating potentials.

The following sections of this chapter will provide further information about features, installation guide, together with some brief information on software and accessories for the PCI-1761 card.

## 1.1 Features

---

- 8 relay output channels and 8 isolated digital input channels
- LED indicators to show activated relays
- 4 Form A-type and 4 Form C-type relay output channels
- Output status read-back
- Keep relay output values when hot system reset
- High-voltage isolation on input channels (3,750 V<sub>DC</sub>)
- High ESD protection (2,000 V<sub>DC</sub>)
- High over-voltage protection (70 V<sub>DC</sub>)
- Wide input range (10 ~ 50 V<sub>DC</sub>)
- Interrupt handling capability
- Board ID

The Advantech PCI-1761 offers the following main features:

### Robust Protection

The PCI-1761 digital input channels feature a robust isolation protection for industrial, lab and machinery automation applications. It durably withstands voltage up to 3,750 V<sub>DC</sub>, preventing your host system from

any incidental harms. If connected to an external input source with surge-protection, the PCI-1761 can offer up to a maximum of 2,000 V<sub>DC</sub> ESD (Electrostatic Discharge) protection. Even with an input voltage rising up to 70 V<sub>DC</sub>, the PCI-1761 can still manage to work properly albeit only for short period of time.

### Wide Input Range

The PCI-1761 has a wide range of input voltage from 10 to 50 V<sub>DC</sub>, and it is suitable for most industrial applications with 12 V<sub>DC</sub>, 24 V<sub>DC</sub> and 48 V<sub>DC</sub> input voltage.

### Reset Protection Fulfills Requirement for Industrial Applications

When the system has undergone a hot reset (i.e. without turning off the system power), the PCI-1761 can either retain outputs values of each channel, or return to its default configuration as open status, depending on its on-board jumper setting. This function protects the system from wrong operations during unexpected system resets.

### Plug-and-Play Function

The PCI-1761 is a Plug-and-Play device, which fully complies with PCI Specification Rev 2.2. During card installation, there is no need to set jumpers or DIP switches. Instead, all bus-related configurations such as base I/O address and interrupt are automatically done by the Plug-and-Play function.

### Board ID

The PCI-1761 has a built-in DIP Switch that helps define each card's ID when multiple PCI-1761 cards have been installed on the same PC chassis. The board ID setting function is very useful when users build their system with multiple PCI-1761 cards. With correct Board ID settings, you can easily identify and access each card during hardware configuration and software programming.

---

#### Note:

 For detailed specifications of the PCI-1761, please refer to *Appendix A, Specifications*.

---

## 1.2 Applications

---

- Industrial On/Off control
- Switch status sensing
- Digital I/O control
- Industrial and lab automation
- SMT/PCB machinery
- Semi-conductor machinery
- PC-based Industrial Machinery
- Testing & Measurement
- Laboratory & Education
- External relay driving

## 1.3 Installation Guide

---

Before you install your PCI-1761 card, please make sure you have the following necessary components:

- PCI-1761 card**
- PCI-1761 User's Manual**
- Driver software**                      Advantech DLL drivers (included in the companion CD-ROM)
- Wiring cable**                              PCL-10137 (optional)
- Wiring board**                             PCLD-880, ADAM-3937 (optional)
- Computer**                                 Personal computer or workstation with a PCI-bus slot (running Windows 95/98/NT/2000)

Some other optional components are also available for enhanced operation:

- Application software**                      ActiveDAQ, GeniDAQ or other third-party software packages

After you get the necessary components and maybe some of the accessories for enhanced operation of your Multifunction card, you can then begin the Installation procedures. Figure 1-1 provides a concise flow chart to give users a broad picture of the software and hardware installation procedures.

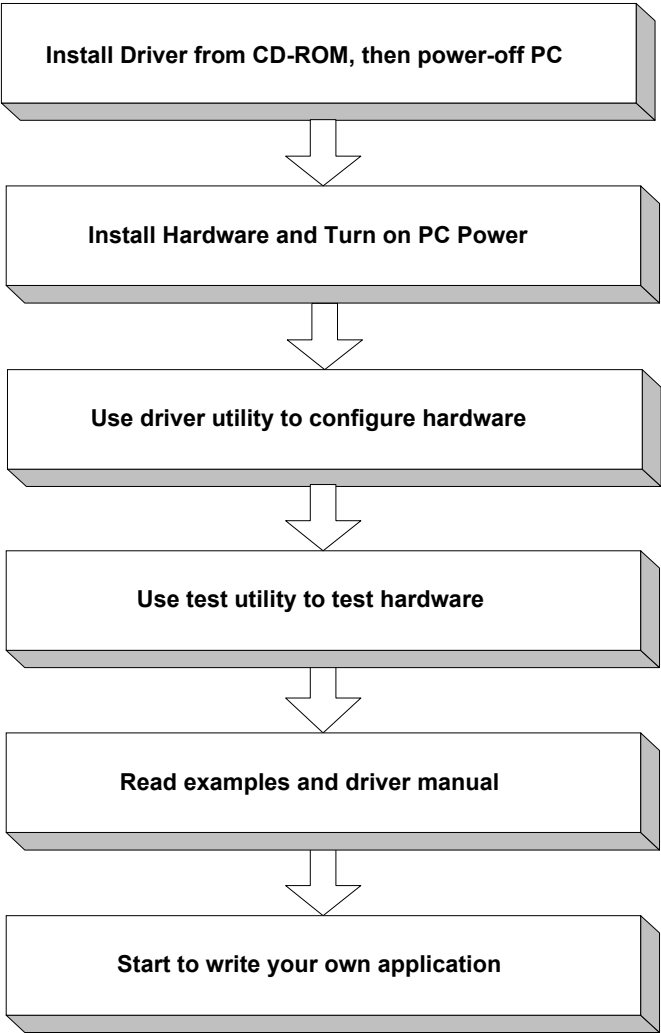

**Fig. 1-1: Installation Flow Chart**



## 1.4 Software Overview

---

Advantech offers a rich set of DLL drivers, third-party driver support and application software to help fully exploit the functions of your PCI-1761 card:

- DLL driver (on the companion CD-ROM)
- LabVIEW driver
- Advantech ActiveDAQ
- Advantech GeniDAQ

Programming choices for DA&C cards: You may use Advantech application software such as Advantech DLL driver. On the other hand, advanced users are allowed another option for register-level programming, although not recommended due to its laborious and time-consuming nature.

### DLL Driver

The Advantech DLL Drivers software is included on the companion CD-ROM at no extra charge. It also comes with all the Advantech DA&C cards. Advantech's DLL driver features a complete I/O function library to help boost your application performance. The Advantech DLL driver for Windows 95/98/NT/2000 works seamlessly with development tools such as Visual C++, Visual Basic, Inprise C++ Builder and Inprise Delphi.

### Register-level Programming

Register-level programming is reserved for experienced programmers who find it necessary to write codes directly at the level of device registers. Since register-level programming requires much effort and time, we recommend that you use the Advantech DLL drivers instead. However, if register-level programming is indispensable, you should refer to the relevant information in *Appendix C, Register Structure and Format*, or to the example codes included on the companion CD-ROM.

## 1.5 DLL Driver Programming Roadmap

---

This section will provide you a roadmap to demonstrate how to build an application from scratch using Advantech DLL driver with your favorite development tools such as Visual C++, Visual Basic, Delphi and C++ Builder. The step-by-step instructions on how to build your own applications using each development tool will be given in the *DLL Drivers Manual*. Moreover, a rich set of example source codes are also given for your reference.

### Programming Tools

Programmers can develop application programs with their favorite development tools:

- Visual C++**
- Visual Basic**
- Delphi**
- C++ Builder**

For instructions on how to begin programming works in each development tool, Advantech offers a *Tutorial* Chapter in the *DLL Drivers Manual* for your reference. Please refer to the corresponding sections in this chapter on the *DLL Drivers Manual* to begin your programming efforts. You can also take a look at the example source codes provided for each programming tool, since they can get you very well-oriented.

The *DLL Drivers Manual* can be found on the companion CD-ROM. Or if you have already installed the DLL Drivers on your system, The *DLL Drivers Manual* can be readily accessed through the **Start** button:

***Start/Programs/Advantech Driver for 95 and 98 (or for NT/2000)/Driver Manual***

The example source codes could be found under the corresponding installation folder such as the default installation path:

***\Program Files\Advantech\ADSAPI\Examples***

For information about using other function groups or other development tools, please refer to the *Creating Windows 95/98/NT/2000 Application with DLL Driver* chapter and the *Function Overview* chapter in the *DLL Drivers Manual*.

## Programming with DLL Driver Function Library

Advantech DLL driver offers a rich function library to be utilized in various application programs. This function library consists of numerous APIs that support many development tools, such as Visual C++, Visual Basic, Delphi and C++ Builder.

According to their specific functions or services, those APIs can be categorized into several function groups:

- ❑ **Digital Input/Output Function Group**
- ❑ **Counter Function Group**
- ❑ **Port Function Group (direct I/O)**
- ❑ **Event Function Group**

For the usage and parameters of each function, please refer to the *Function Overview* chapter in the *DLL Drivers Manual*.

## Troubleshooting DLL Driver Error

Driver functions will return a status code when they are called to perform a certain task for the application. When a function returns a code that is not zero, it means the function has failed to perform its designated function. To troubleshoot the DLL driver error, you can pass the error code to **DRV\_GetErrorMessage** function to return the error message. Or you can refer to the *DLL Driver Error Codes* Appendix in the *DLL Drivers Manual* for a detailed listing of the Error Code, Error ID and the Error Message.

## 1.6 Accessories

---

Advantech offers a complete set of accessory products to support the PCI-1761 card. These accessories include:

### Wiring Cable

- ❑ **PCL-10137** The PCL-10137 shielded cable is specially designed for PCI-1761 cards to provide high resistance to noise. To achieve a better signal quality, the signal wires are twisted in such a way as to form a "twisted-pair cable", reducing cross-talk and noise from other signal sources. Furthermore, its analog and digital lines are separately sheathed and shielded to neutralize EMI/EMC problems.

### Wiring Boards

- ❑ **ADAM-3937** The ADAM-3937 is a 37-pin D-type wiring terminal module for DIN-rail mounting. This terminal module can be readily connected to the Advantech PC-Lab cards and allow easy yet reliable access to individual pin connections for the PCI-1761 card.
  
- ❑ **PCLD-880** The PCLD-880 is a universal screw-terminal board to be used with any of the PC-LabCards which have 37-pin D-type connectors.

## Chapter 2 Installation

---

This chapter gives users a package item checklist, proper instructions about unpacking and step-by-step procedures for both driver and card installation.

### 2.1 Unpacking

---

After receiving your PCI-1761 package, please inspect its contents first. The package should contain the following items:

- PCI-1761 card
- Companion CD-ROM (DLL driver included)
- User's Manual

The PCI-1761 card harbors certain electronic components vulnerable to *electrostatic discharge* (ESD). ESD could easily damage the integrated circuits and certain components if preventive measures are not carefully paid attention to.

***Before removing the card from the antistatic plastic bag, you should take the following precautions to ward off possible ESD damage:***

- Touch the metal part of your computer chassis with your hand to discharge static electricity accumulated on your body. Or one can also use a grounding strap.
- Touch the anti-static bag to a metal part of your computer chassis before opening the bag.
- Take hold of the card only by the metal bracket when removing it out of the bag.

***After taking out the card, you should first:***

- Inspect the card for any possible signs of external damage (loose or damaged components, etc.). If the card is visibly damaged, please notify our service department or our local sales representative immediately. Avoid installing a damaged card into your system.

***Also pay extra caution to the following aspects to ensure proper installation:***

- ✎ Avoid physical contact with materials that could hold static electricity such as plastic, vinyl and Styrofoam.
- ✎ Whenever you handle the card, grasp it only by its edges. **DO NOT TOUCH** the exposed metal pins of the connector or the electronic components.

---

**Note:**

- ✎ Keep the anti-static bag for future use. You might need the original bag to store the card if you have to remove the card from PC or transport it elsewhere.
-

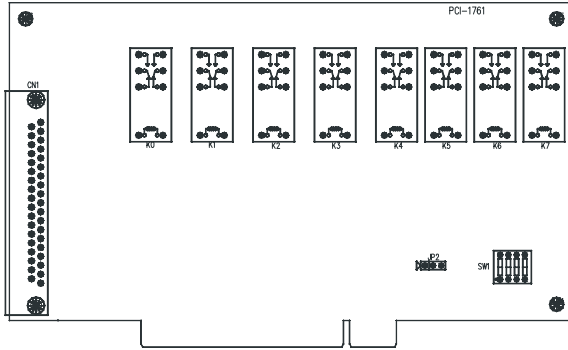

## 2.2 Switch and Jumper Settings

The PCI-1761 card has one function switch settings.



*Fig.2-1: Card connector, jumper and switch locations*

*Table 2-1: Summary of jumper settings*

Names of Jumpers	Function description	
JP2		Keep last status after hot reset
		Default configuration

### Setting the time to reset the relay outputs

Some users will want the capability of clearing each relay output when the system (or PC) issues a reset signal on the PCI bus. Some users will want to clear their relays only as part of system power-on. The PCI-1761 satisfies both these needs by providing jumper JP2. Depending on the application, this capability may allow relay outputs to be "OFF" without requiring a complete shutdown of processes controlled by the card.

## 2.3 I/O connectors

### Pin Assignments

Figure 2-2 shows the pin assignments for the 37-pin I/O connector on the PCI-1761

**Description of pin use:**

	R0_NO	1	20	R3_NO
<b>IDInA* (n=0 ~ 7):</b>	R0_COM	2	21	R3_COM
Isolated digital input A	R0_NC	3	22	R3_NC
<b>IDInB* (n=0 ~ 7):</b>	R1_NO	4	23	R4_NO
Isolated digital input B	R1_COM	5	24	R4_COM
<b>Rn_NO(n=0 ~ 7):</b>	R1_NC	6	25	R5_NO
Normally Open pin of relay output	R2_NO	7	26	R5_COM
<b>Rn_NC(n=0 ~ 7):</b>	R2_COM	8	27	R6_NO
Normally Close pin of relay output	R2_NC	9	28	R6_COM
<b>Rn_COM(n=0 ~ 7):</b>	R7_NO	10	29	N/A
Common pin of relay output	R7_COM	11	30	IDI 0B
	IDI 0A	12	31	IDI 1B
	IDI 1A	13	32	IDI 2B
	IDI 2A	14	33	IDI 3B
	IDI 3A	15	34	IDI 4B
	IDI 4A	16	35	IDI 5B
<b>Note:</b>	IDI 5A	17	36	IDI 6B
Isolated Digital Input is bidiretional.	IDI 6A	18	37	IDI 7B
	IDI 7A	19		

**Fig. 2-2: I/O connector pin assignments**



## 2.4 Driver Installation

---

### Note:

-  We recommend you to install the driver before you install the PCI-1761 card into your system, since this will guarantee a smooth installation process.
- 

The 32-bit DLL driver Setup program for the PCI-1761 card is included on the companion CD-ROM that is shipped with your DA&C card package. Please follow the steps below to install the driver software:

**Step 1:** Insert the companion CD-ROM into your CD-ROM drive.

**Step 2:** The Setup program will be launched automatically if you have the autoplay function enabled on your system. When the Setup Program is launched, you'll see the following Setup Screen.

---

### Note:

-  If the autoplay function is not enabled on your computer, use Windows Explorer or Windows **Run** command to execute SETUP.EXE on the companion CD-ROM.
- 

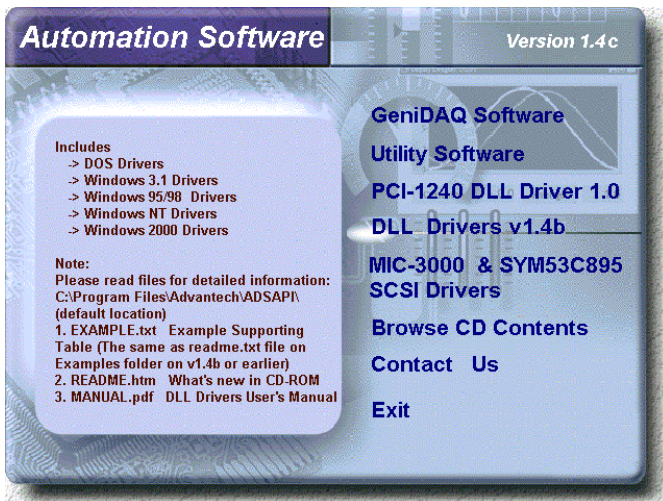

*Fig. 2-3 The Setup Screen of Advantech Automation Software*

**Step 3:** Select the *DLL Drivers* option.

**Step 4:** Select the *Windows 95/98* or *Windows NT* or *Windows 2000* option according to your operating system. Just follow the installation instructions step by step to complete your DLL driver setup.

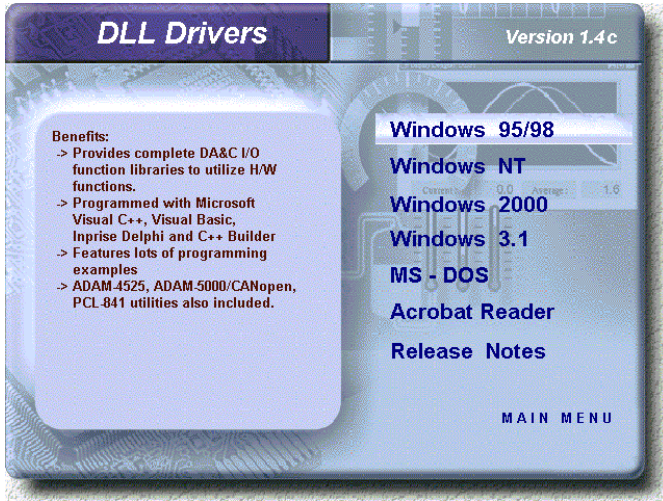

**Fig. 2-4** Different options for Driver Setup

For further information on driver-related issues, an online version of *DLL Drivers Manual* is available by accessing the following path:

***Start/Programs/Advantech Driver for 95 and 98 (or for NT/2000)/Driver Manual***

## 2.5 Hardware Installation

---

### Note:

-  Make sure you have installed the driver first before you install the card (please refer to *2.4 Driver Installation*)
- 

After the DLL driver installation is completed, you can now go on to install the PCI-1761 card in any PCI slot on your computer. But it is suggested that you should refer to the computer user manual or related documentation if you have any doubt. Please follow the steps below to install the card on your system.

- Step 1:** Turn off your computer and unplug the power cord and cables. TURN OFF your computer before installing or removing any components on the computer.
- Step 2:** Remove the cover of your computer.
- Step 3:** Remove the slot cover on the back panel of your computer.
- Step 4:** Touch the metal part on the surface of your computer to neutralize the static electricity that might be on your body.
- Step 5:** Insert the 1761 card into a PCI slot. Hold the card only by its edges and carefully align it with the slot. Insert the card firmly into place. Use of excessive force must be avoided, otherwise the card might be damaged.
- Step 6:** Fasten the bracket of the PCI card on the back panel rail of the computer with screws.
- Step 7:** Connect appropriate accessories (37-pin cable, wiring terminals, etc. if necessary) to the PCI card.
- Step 8:** Replace the cover of your computer chassis. Re-connect the cables you removed in step 2.
- Step 9:** Plug in the power cord and turn on the computer .

---

### Note:

-  In case you installed the card without installing the DLL driver first, *Windows 95/98* will recognize your card as an "unknown device" after rebooting, and will prompt you to provide the necessary driver. You should ignore the prompting messages (just click the **Cancel** button) and set up the driver according to the steps described in *2.4 Driver Installation*.
-

After the PCI-1761 card is installed, you can verify whether it is properly installed on your system in the *Device Manager*:

1. Access the *Device Manager* through *Control Panel/System/Device Manager*.
2. The *device name* of the PCI-1761 should be listed on the *Device Manager* tab on the *System Property* Page.

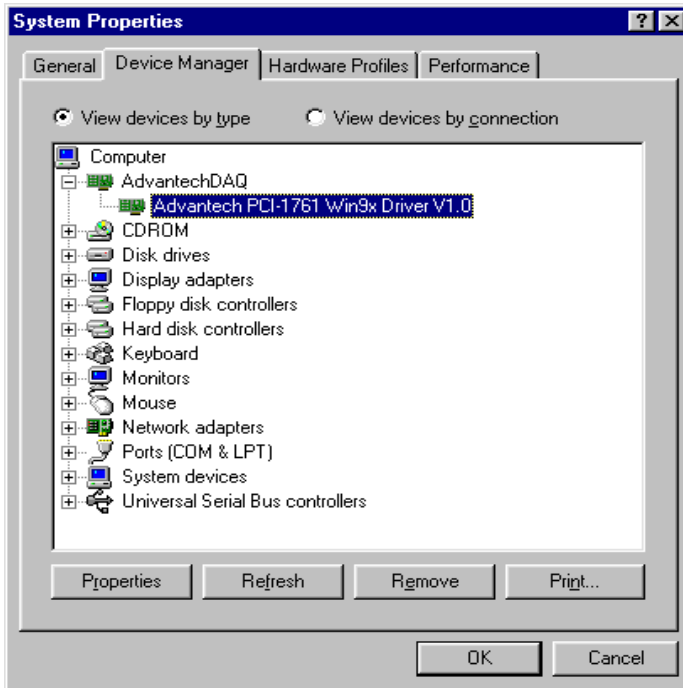

**Fig. 2-5** The device name listed on the *Device Manager*

**Note:**

 If your card is properly installed, you should see the *device name* of your card listed on the *Device Manager* tab. **If you do see your device name listed on it but marked with an exclamation sign "!", it means your card has not been correctly installed.** In this case, remove the card device from the *Device Manager* by selecting its device name and press the **Remove** button. Then go through the driver installation process again.

After your card is properly installed on your system, you can now configure your device using the *Device Installation Program* that has itself already been installed on your system during driver setup. A complete device installation procedure should include *device setup, configuration and testing*. The following sections will guide you through the Setup, Configuration and Testing of your device.

## 2.6 Device Setup & Configuration

---

The *Device Installation* program is a utility that allows you to set up, configure and test your device, and later stores your settings on the system registry. These settings will be used when you call the APIs of Advantech 32-bit DLL drivers.

### Setting Up the Device

**Step 1:** To install the I/O device for your card, you must first run the *Device Installation* program (by accessing *Start/Programs/Advantech Driver for 95 and 98 (or for NT/2000)/Device Installation*).



**Fig. 2-6** *The Advantech Device Installation utility program*

**Step 2:** On the *Device Installation* program window, select the *Setup* menu item on the menu bar, and click the *Device* command (Fig. 2-6) to bring up the *I/O Device Installation* dialog box (Fig. 2-7). You can then view the device(s) already installed on your system (if any) on the *Installed Devices* list box. Since you haven't installed any device yet, you might see a blank list such as the one in (Fig. 2-6).

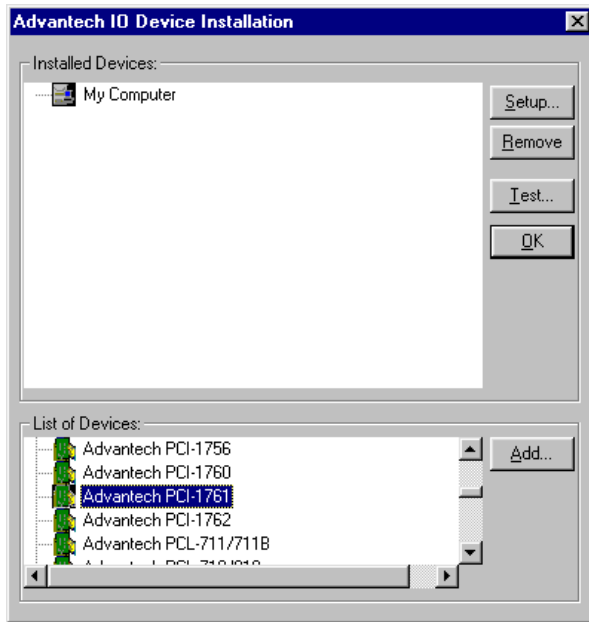

**Fig. 2-7** The *I/O Device Installation* dialog box

**Step 3:** Scroll down the *List of Devices* box to find the device that you wish to install, then click the *Add...* button to evoke the *Device(s) found* dialog box such as one shown in Fig. 2-8. The *Device(s) found* dialog box lists all the installed devices on your system. Select the device you want to configure from the list box and press the **OK** button. After you have clicked **OK**, you will see a *Device Setting* dialog box such as the one in Fig. 2-9.

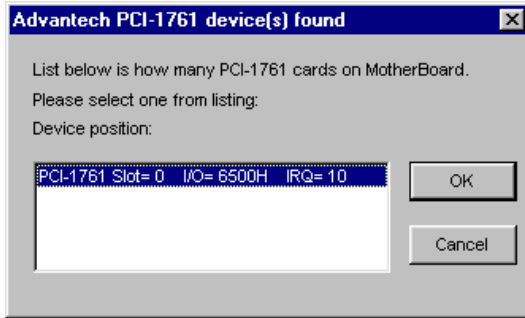

*Fig. 2-8 The "Device(s) Found" dialog box*

## Configuring the Device

**Step 4:** On the *Device Setting* dialog box (Fig. 2-9), you can configure the ID0 ~ ID7 Interrupt trigger mode either as *Rising Edge* or *Falling Edge*, and *Enable* or *Disable* the ID0 ~ ID7.

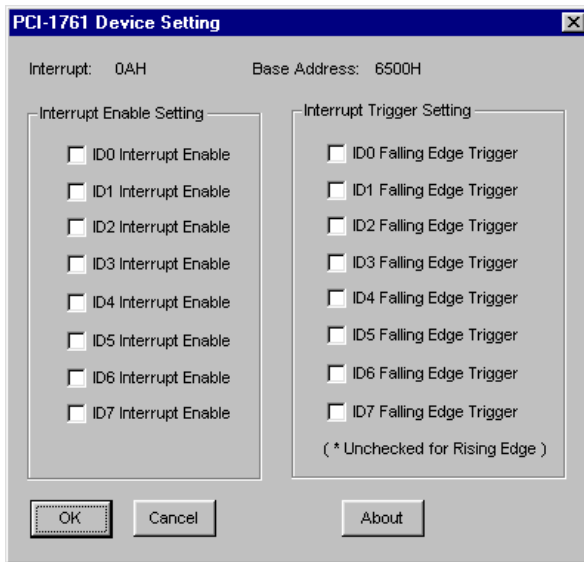

*Fig. 2-9 The Device Setting dialog box*

**Step 5:** After you have finished configuring the device, click **OK** and the *device name* will appear in the *Installed Devices* box as seen in Fig. 2.10

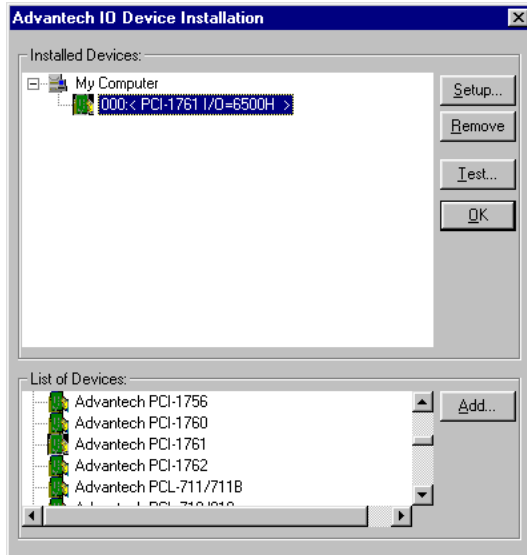

*Fig. 2-10 The Device Name appearing on the list of devices box*

---

**Note:**

 As we have noted, the *device name* "**000:PCI-1761 I/O=6500H**" begins with a *device number* "**000**", which is specifically assigned to each card. The *device number* is passed to the driver to specify which device you wish to control.

---

After your card is properly installed and configured, you can click the **Test...** button to test your hardware by using the testing utility we supplied. For more detailed information, please refer to *Chapter 2* of the *DLL Drivers Manual*.

You can also find the useful examples on the CD-ROM to speed up your programming.



# Chapter 3 Signal Connections

## 3.1 Overview

Maintaining signal connections is one of the most important factors in ensuring that your application system is sending and receiving data correctly. A good signal connection can avoid unnecessary and costly damage to your PC and other hardware devices. This chapter provides useful information about how to connect input and output signals to the PCI-1761 via the I/O connector.

## 3.2 Isolated Digital Input Connections

The PCI-1761 has 8 isolated digital input channels designated IDI0~IDI7.

Each of isolated digital input channel accepts 10~50 V<sub>DC</sub> voltage inputs, and accept bi-directional input. It means that you can apply positive or negative voltage to an isolated input pin (V<sub>in</sub>). The figure below shows how to connect an external input source to one of the card's isolated input channels

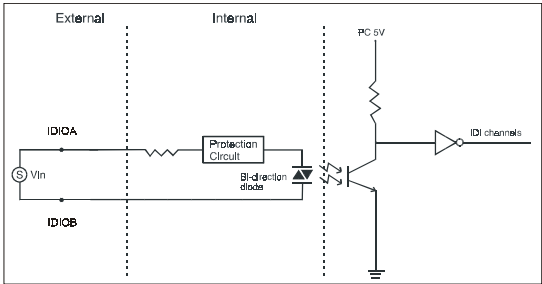

**Figure 3-1: Isolated digital input connections**

### 3.3 Relay connections

After power on, the initial relay output status of PCI-1761 is shown as below:

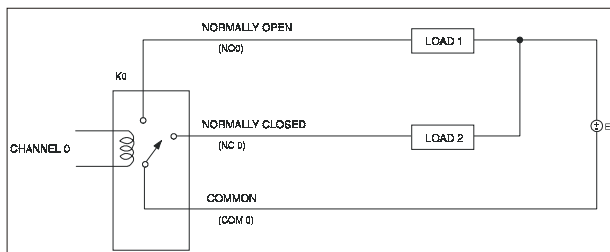

**Figure 3-2: Relay output connection**

A write operation to I/O address, BASE +0, will change the output status of each relay. For example, if Bit 0 of BASE +0 is set "1" (logic high), relay 0, K0, will switch from position "NORMALLY CLOSED", R0\_NC, to position "NORMALLY OPEN", R0\_NO. This means that LOAD2 will be de-energized, while LOAD1 is energized.

To summarize, the "COMMON" line connect to the "NORMALLY CLOSED" line, if the corresponding bit is set as 0 (power-on initial status). Otherwise, if the corresponding bit is set as 1, then the "COMMON" line will connect to the "NORMALLY OPEN" line..

## Appendix A Specifications

*Table A-1: Isolated Digital Input*

Number of Input Channel	8	
Optical Isolation	3750 V <sub>DC</sub>	
Opto-isolator response time	25μs	
Over-voltage Protect	70 V <sub>DC</sub>	
Input Voltage	V <sub>IH</sub> (max.)	50 V <sub>DC</sub>
	V <sub>IH</sub> (min.)	10 V <sub>DC</sub>
	V <sub>IL</sub> (max.)	3 V <sub>DC</sub>
Input Current	10 V <sub>DC</sub>	1.6 mA (typical)
	12 V <sub>DC</sub>	1.9 mA (typical)
	24 V <sub>DC</sub>	4.1 mA (typical)
	48 V <sub>DC</sub>	8.5 mA (typical)
	50 V <sub>DC</sub>	8.9 mA (typical)

*Table A-2: Relay Output*

Number of Output Channel	8	
Relay Type	SPDT (4 Form C and 4 Form A)	
Rating (resistive)	3 A* 250 V <sub>AC</sub> or 3 A* 24 V <sub>DC</sub>	
Max. Switching Power	750 AV, 72 W	
Max. Switching Voltage	250 V <sub>AC</sub> , 24 V <sub>DC</sub>	
Max. Switching Current	3 A	
Min. Switching Load	10mA 5V <sub>DC</sub>	
Breakdown Voltage	5,000 V <sub>AC</sub> for 1 min. (Between coil and contacts)	
Operate time	15 ms max.	
Release time	5 ms max.	
Insulation Resistance	1,000 MΩ min. (at 500 V <sub>DC</sub> )	
Life Expectancy	Mechanical	2x10 <sup>7</sup> ops. min.
	Electrical	2x10 <sup>5</sup> ops. min.(contact rating)

**Note:**

-  The current was limited by the cable and wiring terminal board. For detailed relay specification, please refer to **CD-ROM:\Document\PCI-1761\_Relay\_Spec.pdf**.

**Table A-3: General Specs**

I/O Connector Type	37-pin D-type female	
Dimensions	175 mm x 100 mm (6.9" x 3.9")	
Power Consumption	+5V @ 220 mA (typical) +5V @ 750 mA (max.)	
Temperature	Operating	0 ~ +60 °C (32 ~ 140°F) (refer to IEC 68-2-1,2)
	Storage	-20 ~ +70 °C (-4 ~ 158 °F)
Relative Humidity	5 - 95 % RH non-condensing (refer to IEC 68-2-3)	
Certification	CE Class A certified	

# Appendix B Block diagram

*Fig B-1: System block diagram*

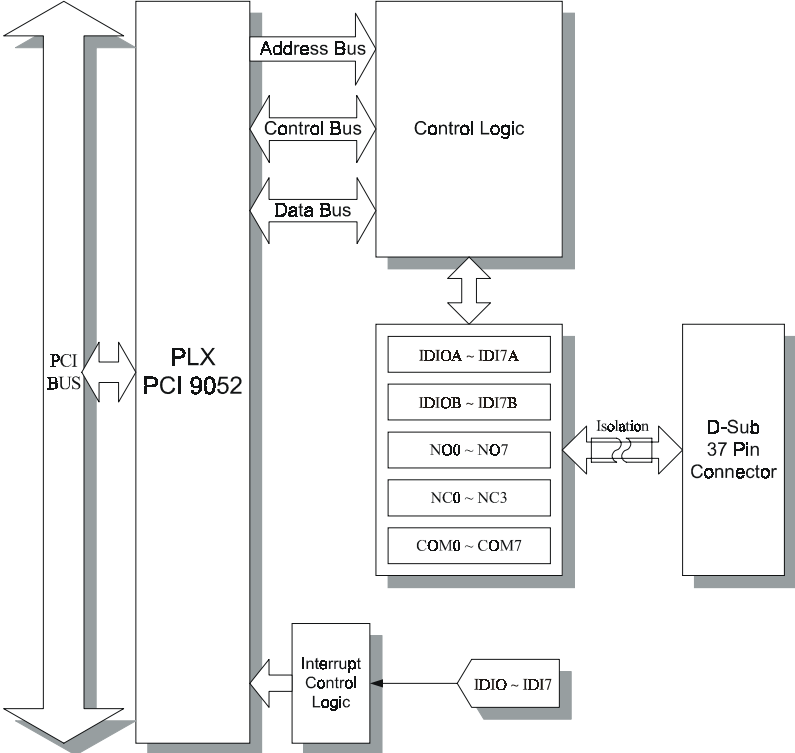



# Appendix C Register Structure and Format

---

## C.1 Overview

---

The PCI-1761 is delivered with an easy-to-use 32-bit DLL driver for user programming under the Windows 95/98/NT/2000 operating system. We advise users to program the PCI-1761 using the 32-bit DLL driver provided by Advantech to avoid the complexity of low-level programming by register.

The most important consideration in programming the PCI-1761 the register level is to understand the function of the card's registers. The information in the following sections is provided only for users who would like to do their own low-level programming.

## C.2 I/O Port Address Map

---

The PCI-1761 requires 32 consecutive addresses in the PC's I/O space. The address of each register is specified as an offset from the card's base address. For example, BASE+0 is the card's base address and BASE+7 is the base address plus seven bytes.

Table C-1 shows the function of each register of the PCI-1761 or driver and its address relative to the card's base address.

**Table C-1: Register function**

Base Addr, + Hex		7	6	5	4	3	2	1	0
0H	R	<b>Relay Output Status</b>							
		RS7	RS6	RS5	RS4	RS3	RS2	RS1	RS0
	W	<b>Relay Output</b>							
RO7		RO6	RO5	RO4	RO3	RO2	RO1	RO0	
1H	R	<b>Isolated Digital Input</b>							
		IDI7	IDI	IDI5	IDI4	IDI3	IDI2	IDI1	IDI0
	W	<b>N/A</b>							
2H	R	<b>Board ID Register</b>							
						BD3	BD2	BD1	BD0
	W	<b>N/A</b>							
3H	R	<b>Interrupt Enable Status</b>							
		IDI7EN	IDI6EN	IDI5EN	IDI4EN	IDI3EN	IDI2EN	IDI1EN	IDI0EN
	W	<b>Interrupt Enable Register</b>							
IDI7EN		IDI6EN	IDI5EN	IDI4EN	IDI3EN	IDI2EN	IDI1EN	IDI0EN	
4H	R	<b>Interrupt Triggering Status</b>							
		IDI7RF	IDI6RF	IDI5RF	IDI4RF	IDI3RF	IDI2RF	IDI1RF	IDI0RF
	W	<b>Interrupt Triggering Register</b>							
IDI7RF		IDI6RF	IDI5RF	IDI4RF	IDI3RF	IDI2RF	IDI1RF	IDI0RF	
5H	R	<b>Interrupt Flag</b>							
		IDI7F	IDI6F	IDI5F	IDI4F	IDI3F	IDI2F	IDI1F	IDI0F
	W	<b>Interrupt Clear Register</b>							
IDI7CLR		IDI6CLR	IDI5CLR	IDI4CLR	IDI3CLR	IDI2CLR	IDI1CLR	IDI0CLR	

### C.3 Relay I/O Registers - BASE+0H

The PCI-1761 offers 8-ch relay actuators. These I/O channels use the input and output ports at addresses **BASE+0H**.

*Table C-2: Register for relay output status*

Read	Relay Output Status							
Bit #	7	6	5	4	3	2	1	0
BASE +0H	RS7	RS6	RS5	RS4	RS3	RS2	RS1	RS0

*Table C-3: Register for relay output*

Write	Relay Output							
Bit #	7	6	5	4	3	2	1	0
BASE +0H	RO7	RO6	RO5	RO4	RO3	RO2	RO1	RO0

**Note:**

 The default configuration of the digital output channels is a logic 0.

This avoids damaging external devices during system start-up or reset since the power on status is set to the default value.



## C.4 Isolated Digital Input Registers - BASE+1H

---

The PCI-1761 offers 8-ch isolated digital input channels. These channels use the input ports at addresses **BASE+1H**.

*Table C-4: Register for isolated digital input*

Read	Isolated Digital Input							
Bit #	7	6	5	4	3	2	1	0
BASE +1H	IDI7	IDI6	IDI5	IDI4	IDI3	IDI2	IDI1	IDI0

## C.5 Board ID - BASE+2H

---

The PCI-1761 offers Board ID register **BASE+2H**. With correct Board ID settings, user can easily identify and access each card during hardware configuration and software programming.

*Table C-5: Register for Board ID*

Read	Board ID							
Bit #	7	6	5	4	3	2	1	0
BASE +2H					BD3	BD2	BD1	BD0

**BD3 ~ DB0**

**Board ID**

BD0 LSB of the Board ID

BD3 MSB of the Board ID

## C.6 Interrupt Status Register - BASE+3H/4H/5H

The **Interrupt Status Register** control the status of eight interrupt signal sources (IDI0 ~ IDI7).

**Table C-6: Register for interrupt status**

Read	Interrupt Status Register							
Bit #	7	6	5	4	3	2	1	0
BASE +3H	IDI7EN	IDI6EN	IDI5EN	IDI4EN	IDI3EN	IDI2EN	IDI1EN	IDI0EN
BASE +4H	IDI7RF	IDI6RF	IDI5RF	IDI4RF	IDI3RF	IDI2RF	IDI1RF	IDI0RF
BASE +5H	IDI7F	IDI6F	IDI5F	IDI4F	IDI3F	IDI2F	IDI1F	IDI0F

### IDI $n$ F

#### Interrupt flag bits ( $n = 0 \sim 7$ )

This bit is a flag indicating the status of an interrupt. User can read this bit to get the status of the interrupt

- 0 No interrupt
- 1 Interrupt occurred

### IDI $n$ RF

#### Interrupt enable control bits ( $n = 0 \sim 7$ )

Read this bit to Enable/Disable the interrupt.

- 0 Disable
- 1 Enable

### IDI $n$ EN

#### Interrupt triggering control bits ( $n = 0 \sim 7$ )

The interrupt can be triggered by a rising edge or falling edge of the interrupt signal, as determined by the value in this bit.

- 0 Rising edge trigger
- 1 Falling edge trigger

## C.7 Interrupt Control Register - BASE+3H/4H/5H

The **Interrupt Control Register** control the status of two interrupt signal sources (IDI0 ~ IDI7). The user can clear the interrupt by writing its corresponding value to the **Interrupt Control Register**, as shown in below table.

*Table C-7: Register for interrupt control*

Write	Interrupt Control Register							
Bit #	7	6	5	4	3	2	1	0
BASE +3H	IDI7EN	IDI6EN	IDI5EN	IDI4EN	IDI3EN	IDI2EN	IDI1EN	IDI0EN
BASE +4H	IDI7RF	IDI6RF	IDI5RF	IDI4RF	IDI3RF	IDI2RF	IDI1RF	IDI0RF
BASE +5H	IDI7CLR	IDI6CLR	IDI5CLR	IDI4CLR	IDI3CLR	IDI2CLR	IDI1CLR	IDI0CLR

### **IDI $n$ CLR**

#### **Interrupt clear control bits ( $n = 0 \sim 7$ )**

This bit must first be cleared to service the next interrupt.

- 0 Don't care
- 1 Clear the interrupt

### **IDI $n$ RF**

#### **Interrupt enable control bits ( $n = 0 \sim 7$ )**

Read this bit to Enable/Disable the interrupt.

- 0 Disable
- 1 Enable

### **IDI $n$ EN**

#### **Interrupt triggering control bits ( $n = 0 \sim 7$ )**

The interrupt can be triggered by a rising edge or falling edge of the interrupt signal, as determined by the value in this bit.

- 0 Rising edge trigger
- 1 Falling edge trigger