

PCI-1752/54/56 Quick Start

Unpacking

The PCI-1752/54/56 package should contain the following items:

- PCI-1752/54/56 card
- Companion CD-ROM disc
- User's Manual
- Quick Start

Driver Installation

Step 1: Insert the companion disc into your CD-ROM drive.

Step 2: The *Setup Program* will be launched automatically, and you'll see the following *Setup Screen*.

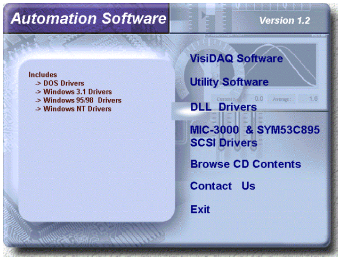

Select the **DLL Drivers** installation option. (If *autoplay* is not enabled, please use *Windows Explorer* or *Windows Run* command to execute *setup.exe* on CD-ROM).

Step 3: Select the **Windows 95/98** or **Windows NT** option according to your operating system.

Step 4: Follow the installation instructions step by step to complete your DLL driver setup.

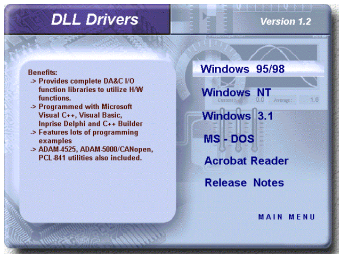

Hardware Installation

- Step 1:** Turn off your computer and unplug the power cord and cables
- Step 2:** Remove the cover of your computer
- Step 3:** Remove the slot cover on the back panel of your computer
- Step 4:** Touch the metal part of your computer chassis to discharge static electricity on your body
- Step 5:** Adjust DIP switch SW1 on board to set the card's board ID.
- Step 6:** Insert the PCI-1752/54/56 card into a PCI slot. Hold the card only by its edges and carefully align it with the slot, then insert the card firmly into place. Use of excessive force must be avoided otherwise the card might be damaged.
- Step 7:** Fasten the bracket of the PCI card on the back panel rail of the computer with screws
- Step 8:** Connect appropriate accessories (100-pin cable, wiring terminals, etc., if necessary) to the PCI card.
- Step 9:** Replace the cover of your computer chassis. Re-connect the cables you removed in step 2.
- Step 10:** Plug in the power cord and turn on the computer

Verifying your Installation

- ◆ Access the *Device Manager* through the *Control Panel/System/Device Manager*. On the *Device Manager* tab of the *System Property* sheet, you can see the *Device Name* of the PCI-1752/54/56 listed on it.

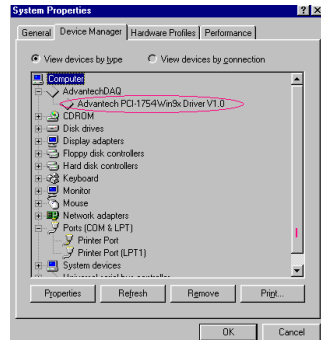

Device Installation

Step 1: Run the *Device Installation* program (by accessing *Start/Programs/ Advantech Driver for 95 and 98 (or for NT)/Device Installation*).

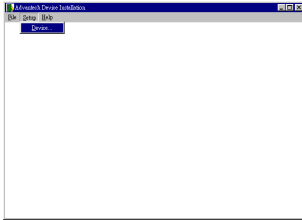

Step 2: On the *Device Installation* program window, select the *Setup* menu item on the menu bar, and click the *Device* command to bring up the *I/O Device Installation* dialog box as below:

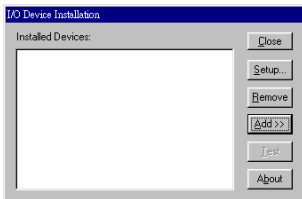

Step 3: Click the *Add>>* button and the *List of Devices* box appears below the original *Installed Devices* box on the dialog box.

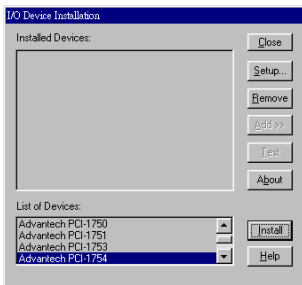

Step 4: Scroll down the *List of Devices* box to find the device that you wish to configure, then click the *Install* button to bring up the *Device Found(s)* dialog box as shown below:

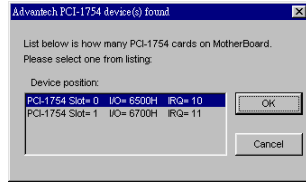

Step 5: After selecting a device and click *OK*, the *Device Setting* dialog box will pop up. You can configure various settings for the selected device.

Step 6: After you have finished configuring of the device, click *OK* and the device will appear in the *Installed Devices* box as seen below:

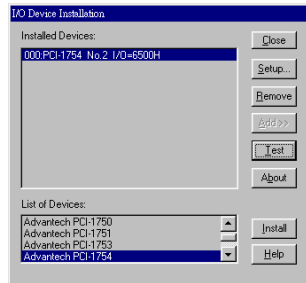

Step 7: After your card is properly installed and configured, you can click the *Test* button to test your hardware.

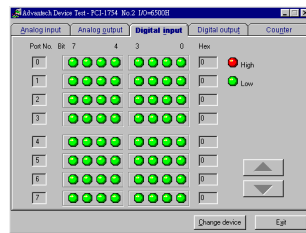

Step 8: You can test your hardware by using the testing utility we supplied. For more detailed information, please refer to Chapter 2 of the User's Manual .

Copyright

This documentation and the software included with this product are copyrighted 2000 by Advantech Co., Ltd. All rights are reserved. Advantech Co., Ltd. reserves the right to make improvements in the products described in this manual at any time without notice.

No part of this manual may be reproduced, copied, translated or transmitted in any form or by any means without the prior written permission of Advantech Co., Ltd. Information provided in this manual is intended to be accurate and reliable. However, Advantech Co., Ltd. assumes no responsibility for its use, nor for any infringements of the rights of third parties which may result from its use.

Acknowledgments

PC-LabCard is a trademark of Advantech Co., Ltd. IBM and PC are trademarks of International Business Machines Corporation. MS-DOS, Windows®, Microsoft® Visual C++ and Visual BASIC are trademarks of Microsoft® Corporation. Intel® and Pentium® are trademarks of Intel Corporation. Delphi and C++Builder are trademarks of Inprise Corporation.

CE notification

The PCI-1752/1754/1756, developed by ADVANTECH CO., LTD., has passed the CE test for environmental specifications when shielded cables are used for external wiring. We recommend the use of shielded cables. This kind of cable is available from Advantech.

Please contact your local supplier for ordering information.

On-line Technical Support

For technical support and service, please visit our support website

Part No. 2003175400

1st Edition

Printed in Taiwan

April 2000

Contents

1. Introduction	1
1.1 Features	1
1.2 Installation Guide	6
1.3 Accessories	6
2. Installation	7
2.1 Unpacking	7
2.2 Driver Installation	8
2.3 Hardware Installation	9
2.4 Device Setup & Configuration	12
2.5 Device Testing	16
3. Signal Connections	19
3.1 I/O Connector Pin Assignment	19
3.2 Location of Jumpers and DIP switch	19
3.3 Isolated Digital Input Connections	27
3.4 Isolated Digital Output Connections	28
3.5 Field Wiring Considerations	29
4. Operation	31
4.1 Interrupt Function	31
4.2 Board ID	33
4.3 Channel-Freeze Function	34
Appendix A Specifications	37
Appendix B Block Diagram	39

Appendix C Register Structure and Format 43

- C.1 Overview 43
- C.2 I/O Port Address Map 43
- C.3 PCI-1752 Register Format 44
- C.4 PCI-1754 Register Format 45
- C.5 PCI-1756 Register Format 46

Appendix D ADAM-3951 Pin Assignment 47

Figures

Figure 1-1: Installation Flow Chart	5
Figure 2-1: The Setup Screen of Advantech Automation Software	8
Figure 2-2: Different options for Driver Setup	9
Figure 2-3: The device name listed on the Device Manager	11
Figure 2-4: The “exclamation mark” (!) on the device name indicating improper installation of the card	11
Figure 2-5: The Advantech Device Installation utility program	12
Figure 2-6: The I/O Device Installation dialog box	13
Figure 2-7: Selecting the device you want to install	13
Figure 2-8: The “Device(s) Found” dialog box	14
Figure 2-9: The Device Setting dialog box of PCI-1752	14
Figure 2-10: The Device Setting dialog box of PCI-1754	14
Figure 2-11: The Device Name appearing on the list of devices box	15
Figure 2-12: PCI-1754 Digital Input tab on the Device Test dialog box	16
Figure 2-13: PCI-1754 Digital Input tab on the Device Test dialog box	17
Figure 2-14: PCI-1752 Digital Output tab on the Device Test dialog box	17
Figure 4-1: The device No. and board ID on dialog box	34
Figure 4-2: The wiring in wet/dry contact input mode	36

Tables

Table 1-1: PCI-1752/1754/1756 Features Comparison	4
Table 3-1: PCI-1752 I/O Connector Signal Description	21
Table 3-2: PCI-1754 I/O Connector Signal Description	23
Table 3-3: PCI-1756 I/O Connector Signal Description	25
Table 3-4: JP1: Power on configuration after hot reset	28
Table 4-1: Interrupt control register bit map	31
Table 4-2: Latch port data disable/enable control bit	32
Table 4-3: Interrupt disable/enable control bit values	32
Table 4-4: Interrupt triggering edge control bit values	32
Table 4-5: Interrupt flag bit values	33
Table 4-6: Board ID register	33
Table 4-7: Board ID setting	34
Table 4-8: JP2: Channel-Freeze function input mode	35
Table 4-9: Channel-Freeze function register	36
Table 4-10: Channel-Freeze function bit value	36

1. Introduction

Thank you for buying the Advantech PCI-1752/1754/1756 DAS card. The Advantech PCI-1752/1754/1756 DAS card is a powerful data acquisition (DAS) card for the PCI bus. It features a unique circuit design and complete functions for data acquisition and control. PCI-1752/1754/1756 DAS card provides specific functions for different user requirements:

PCI-1752 64-channel Isolated Digital Output card

PCI-1754 64-channel Isolated Digital Input Card

PCI-1756 32/32-channel Isolated Digital I/O DAS card

The following sections of this chapter will provide further information about features of the DAS cards, a Quick Start for installation, together with some brief information on software and accessories for the PCI-1752/1754/1756 DAS card.

1.1 Features

The Advantech PCI-1752/1754/1756 DAS card provides users with the most requested measurement and control functions as seen below:

PCI-1752 DAS card

- 64 isolated digital output channels
- High-voltage isolation on output channels (2,500 V_{DC})
- Wide output range (5 ~ 40 V_{DC})
- High-sink current for isolated output channels (200 mA max./channel)
- Board ID
- Output status read-back
- Digital output value retained after hot system reset
- Channel-Freeze* function
- Output status read-back
- Provides convenient wiring terminal module with LED indicators for DIN-rail mounting
- High-density 100-pin SCSI connector

PCI-1754 DAS card

- 64 isolated digital input channels
- High-voltage isolation for input channels (2,500 V_{DC})

- Wide input range (10 ~ 50 V_{DC})
- High ESD protection (2,000 V_{DC})
- High over-voltage protection (70 V_{DC})
- Board ID
- Interrupt handling capability
- Provides convenient wiring terminal module with LED indicators for DIN-rail mounting
- High-density 100-pin SCSI connector

PCI-1756 DAS card

- 32/32 isolated digital input/output channels
- High-voltage isolation for input/output channels (2,500 V_{DC})
- Wide input range (10 ~ 50 V_{DC})
- Wide output range (5 ~ 40 V_{DC})
- High-sink current on isolated output channels (200 mA max./channel)
- High over-voltage protection (70 V_{DC}) for input channels
- High ESD protection (2,000 V_{DC}) for input channels
- Board ID
- Output status read-back for output channels
- Digital output value retained after hot system reset
- Channel-Freeze* function for output channels
- Interrupt handling capability
- Provides convenient wiring terminal module with LED indicators for DIN-rail mounting
- High-density 100-pin SCSI connector

The Advantech PCI-1752/1754/1756 DAS card offers the following main features:

Robust Protection (PCI-1752/1754/1756)

The PCI-1752/1754/1756 features a robust isolation protection for applications in industrial, lab and machinery automation. The PCI-1752/1754/1756 can durably withstand a voltage up to 2,500 V_{DC}, preventing your host system from any incidental harms. The PCI-1754/1756, if connected to an external input source with surge-protection, can offer

up to a maximum of 2,000 V_{DC} ESD (Electrostatic Discharge) protection for input channels. Even with an input voltage rising up to 70 V_{DC}, the input channels of PCI-1754/1756 can still manage to work properly albeit only for a short period of time.

Wide Input/Output Range (PCI-1752/1754/1756)

The PCI-1754/1756 has a wide range of input voltage from 10 to 50 V_{DC}, and it is suitable for most industrial applications with 12 V_{DC}, 24 V_{DC} and 48 V_{DC} input voltage. The PCI-1752/1756 also features a wide output voltage range from 5 to 40 V_{DC}, suitable for most industrial applications with 12 V_{DC} / 24 V_{DC} output voltage. In the mean time, we are also ready to serve your special needs for specific input/output voltage range. Do not hesitate to ask us about tailoring our standard products to meet your specifications. All these merits make PCI-1752/1754/1756 the best choice for industrial applications.

Board ID Setting (PCI-1752/1754/1756)

The PCI-1752/1754/1756 has a built-in DIP switch that helps define each card's ID when multiple cards have been installed on the same PC chassis. The board ID setting function is very useful when users build their system with multiple PCI-1752/1754/1756 cards. With correct Board ID settings, you can easily identify and access each card during hardware configuration and software programming.

Channel-Freeze Function (PCI-1752/1756)

The PCI-1752/1756 provides *Channel-Freeze* function, which can be enabled either in dry contact or wet contact mode (selectable by the on-board jumper). When the *Channel-Freeze* function is enabled, the last status of each digital output channel will be safely kept for emergency use. Moreover, you can enable this function through software as it is useful in software simulation and testing program.

Reset Protection (PCI-1752/1756)

When the system has undergone a hot reset (i.e. without turning off the system power), the PCI-1752/1756 can either retain outputs values of each channel, or return to its default configuration as open status, depending on its on-board jumper setting. This function protects the system from wrong operations during unexpected system resets.

PCI-1752/1754/1756 Features Comparison

PCI-Bus Isolated Digital I/O Card	PCI-1752	PCI-1754	PCI-1756
64 IDO Channels	✓	-	-
64 IDI Channels	-	✓	-
32 IDI/ 32 IDO Channels	-	-	✓
Board ID	✓	✓	✓
2,500 V _{DC} Isolation	✓	✓	✓
Wide Input Range 10 ~ 50V _{DC}	-	✓	✓
Wide Output Range 5 ~ 40V _{DC}	✓	-	✓
Keep last status after hot reset	✓	-	✓
High-Sink Current (200 mA/Ch) on IDO Channels	✓	-	✓
High Over-Voltage Protection	-	✓	✓
2,000 V _{DC} ESD Protection	-	✓	✓
Output Status Readback	✓	-	✓
Channel-Freeze Function	✓	-	✓
Interrupt Handling	-	✓	✓
Wiring Terminal Module with LEDs	✓	✓	✓
100-pin SCSI-II Connector	✓	✓	✓

Table 1-1 PCI-1752/1754/1756 Features Comparison

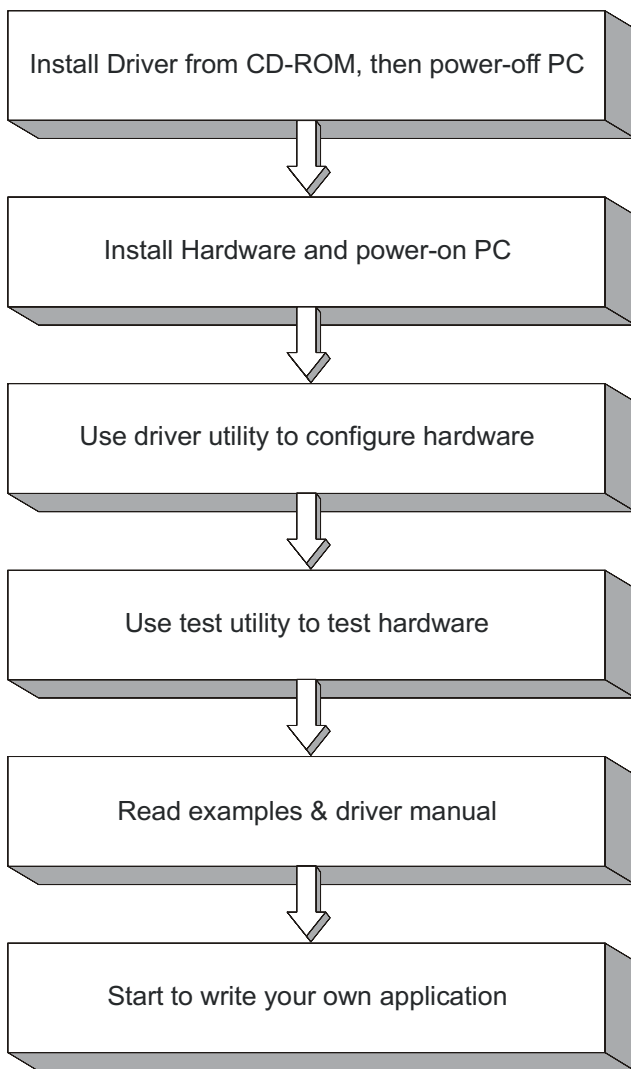

Fig. 1-1 Installation Flow Chart

2. Installation

This chapter gives users a package item checklist, proper instructions about unpacking and step-by-step procedures for both driver and card installation.

2.1 Unpacking

After receiving your PCI-1752/1754/1756 package, please inspect its contents first. The package should contain the following items:

- PCI-1752/1754/1756 card
- Companion CD-ROM (DLL driver included)
- User's Manual
- Quick Start

The PCI-1752/1754/1756 card harbors certain electronic components that are vulnerable to *electrostatic discharge* (ESD). ESD could easily damage the integrated circuits and certain components if preventive measures are not carefully paid attention to. ***Before removing the card from the antistatic plastic bag, you should take following precautions to ward off possible ESD damage:***

- Touch the metal part of your computer chassis with your hand to discharge static electricity accumulated on your body. Or one can also use a grounding strap.
- Touch the antistatic bag to a metal part of your computer chassis before opening the bag.
- Take hold of the card only by the metal bracket when removing it out of the bag.

After taking out the card, first you should:

- Inspect the card for any possible signs of external damage (loose or damaged components, etc.). If the card is visibly damaged, please notify our service department or our local sales representative immediately. Avoid installing a damaged card into your system.

Also pay extra caution to the following aspects to ensure proper installation:



Avoid physical contact with materials that could hold static electricity such as plastic, vinyl and Styrofoam.



Whenever you handle the card, grasp it only by its edges. **DO NOT TOUCH** the exposed metal pins of the connector or the electronic components.

Note:

- ✎ Keep the antistatic bag for future use. You might need the original bag to store the card if you have to remove the card from PC or transport it elsewhere.
-

2.2 Driver Installation

We recommend you to install the driver before you install the PCI-1752/1754/1756 card into your system, since this will guarantee a smooth installation process.

The 32-bit DLL driver Setup program for the PCI-1752/1754/1756 card is included on the companion CD-ROM that is shipped with your DAS card package. Please follow the steps below to install the driver software:

Step 1: Insert the companion CD-ROM into your CD-ROM drive.

Step 2: The Setup program will be launched automatically if you have the autoplay function enabled on your system. When the Setup Program is launched, you'll see the following Setup Screen.



Fig. 2-1 The Setup Screen of Advantech Automation Software

Note:

- ✎ If the autoplay function is not enabled on your computer, use Windows Explorer or Windows *Run* command to execute SETUP.EXE on the companion CD-ROM.
-

Step 3: Select the *DLL Drivers* option.

Step 4: Select the *Windows 95/98* or *Windows NT* option according to your operating system. Just follow the installation instructions step by step to complete your DLL driver setup.

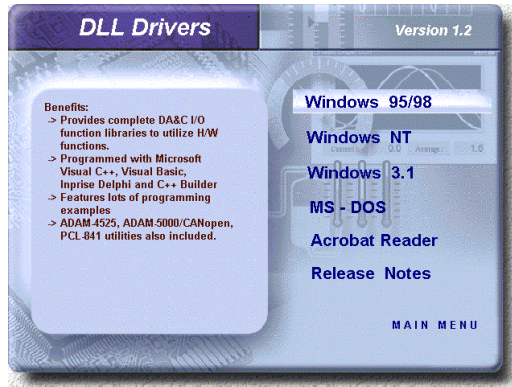



Fig. 2-2 Different options for Driver Setup

For further information on driver-related issues, an online version of *DLL Drivers Manual* is available by accessing the following path:

Start/Programs/Advantech Driver for 95 and 98 (or for NT)/Driver Manual

2.3 Hardware Installation

Note:

 Make sure you have installed the driver first before you install the card (please refer to *Section 2.2 Driver Installation*)

After the DLL driver installation is completed, you can now go on to install the PCI-1752/54/56 card in any PCI slot on your computer. But it is suggested that you should refer to the computer user manual or related documentations if you have any doubt. Please follow the steps below to install the card on your system.

Step 1: Turn off your computer and unplug the power cord and cables.

 **TURN OFF** your computer before installing or removing any components on the computer.

Step 2: Remove the cover of your computer.

- Step 3:** Remove the slot cover on the back panel of your computer.
- Step 4:** Touch the metal part on the surface of your computer to neutralize the static electricity that might be on your body.
- Step 5:** Adjust DIP switch SW1 on board to set the card's board ID.
- Step 6:** Insert the PCI-1752/54/56 card into a PCI slot. Hold the card only by its edges and carefully align it with the slot. Insert the card firmly into place. Use of excessive force must be avoided, otherwise the card might be damaged.
- Step 7:** Fasten the bracket of the PCI card on the back panel rail of the computer with screws.
- Step 8:** Connect appropriate accessories (100-pin cable, wiring terminals, etc. if necessary) to the PCI card.
- Step 9:** Replace the cover of your computer chassis. Re-connect the cables you removed in step 2.
- Step10:** Plug in the power cord and turn on the computer .

Note:

 In case you installed the card without installing the DLL driver first, Windows 95/98 will recognize your card as an “unknown device” after reboot, and will prompt you to provide necessary driver. You should ignore the prompting messages (just click the **Cancel** button) and set up the driver according to the steps described in *Section 2.2 Driver Installation*.

After the PCI-1752/1754/1756 card is installed, you can verify whether it is properly installed on your system in the *Device Manager*:

1. Access the *Device Manager* through *Control Panel/System/Device Manager*.
2. The *device name* of the PCI-1752/1754/1756 should be listed on the *Device Manager* tab on the *System Property* Page.

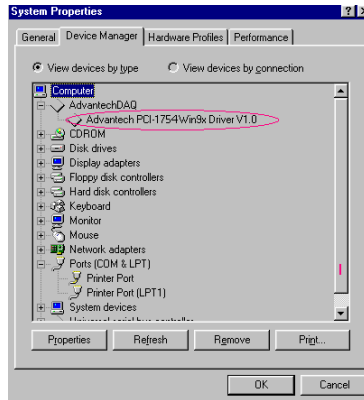



Fig. 2-3 The device name listed on the Device Manager

Note:

 If your card is properly installed, you should see the *device name* of your card listed on the *Device Manager* tab. **If you do see your device name listed on it but marked with an exclamation sign “!” (Fig. 2-4), it means your card has not been correctly installed.** In this case, remove the card device from the *Device Manager* by selecting its device name and press the **Remove** button. Then go through the driver installation process again.

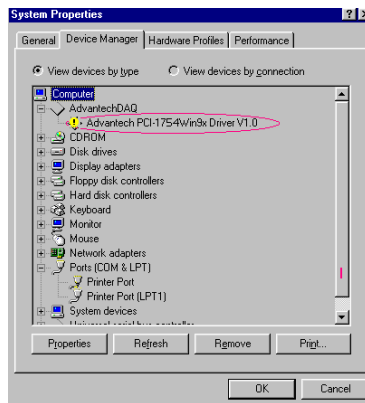

Fig. 2-4 The “exclamation mark” (!) on the device name indicating improper installation of the card

After your card is properly installed on your system, you can now configure your device using the *Device Installation* Program that has itself already been installed on your system during driver setup. A complete device installation procedure should include *device setup*, *configuration* and *testing*. The following sections will guide you through the Setup, Configuration and Testing of your device.

2.4 Device Setup & Configuration

The *Device Installation* program is a utility that allows you to set up, configure and test your device, and later stores your settings on the system registry. These settings will be used when you call the APIs of Advantech 32-bit DLL drivers.

Setting Up the Device

Step 1: To install the I/O device for your card, you must first run the *Device Installation* program (by accessing **Start/Programs/Advantech Driver for 95 and 98 (or for NT)/Device Installation**).

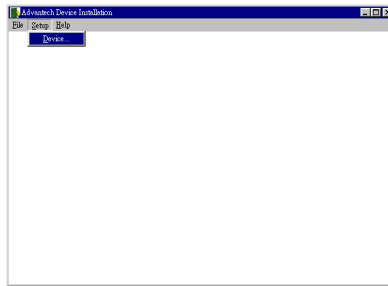

Fig. 2-5 The Advantech Device Installation utility program

Step 2: On the *Device Installation* program window, select the *Setup* menu item on the menu bar, and click the *Device* command (Fig. 2-5) to bring up the *I/O Device Installation* dialog box (Fig. 2-6). You can then view the device(s) already installed on your system (if any) on the *Installed Devices* list box. Since you haven't installed any device yet, you might see a blank list such as below (Fig. 2-6).

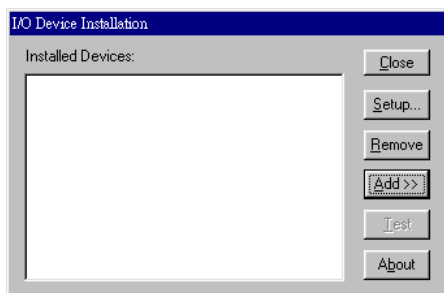

Fig. 2-6 The I/O Device Installation dialog box

Step 3: Click the *Add>>* button and a *List of Devices* box will appear right below the original *Installed Devices* box (Fig. 2-7).

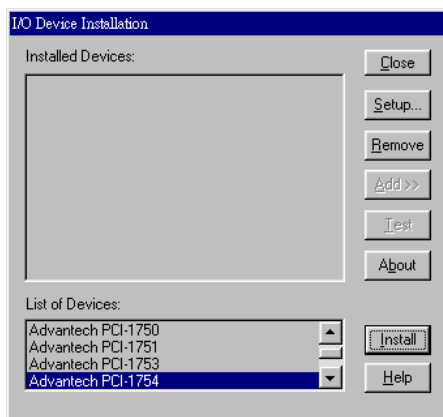

Fig. 2-7 Selecting the device you want to install

Step 4: Scroll down the *List of Devices* box to find the device that you wish to install, then click the **Install** button to evoke the *Device(s) Found* dialog box such as one shown in Fig. 2-8. The *Device(s) Found* dialog box lists all the installed devices on your system. Select the device you want to configure from the list box and press the **OK** button. After you have clicked **OK**, you will see a *Device Setting* dialog box such as the one in Fig. 2-9 and 2-10.

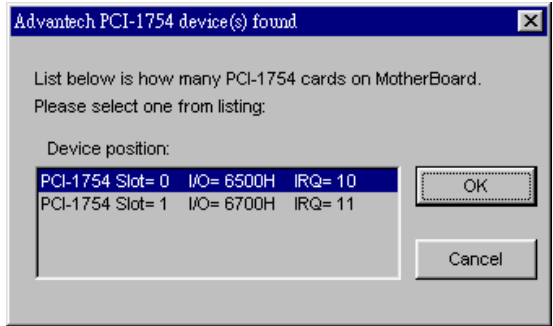

Fig. 2-8 The “Device(s) Found” dialog box

Configuring the Device

Step 5: On the *Device Setting* dialog box (Fig. 2-9, 2-10), you can enable/disable the Channel-Freeze function of PCI-1752/1756 or configure the interrupt functions of each digital input group of PCI-1754/1756.

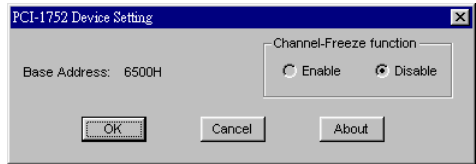

Fig. 2-9 The Device Setting dialog box of PCI-1752

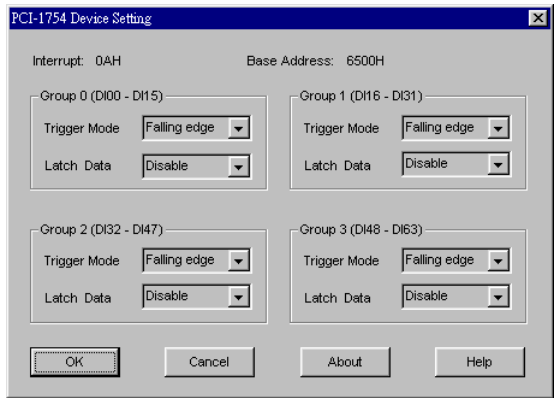

Fig. 2-10 The Device Setting dialog box of PCI-1754

Step 6: After you have finished configuring the device, click **OK** and the *device name* will appear in the *Installed Devices* box as seen below:

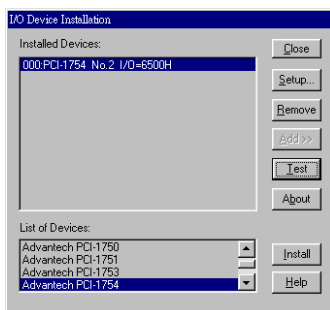



Fig. 2-11 The Device Name appearing on the list of devices box

Note:

 As we have noted, the *device name* “000:PCI-1754 No.2 I/O=6500H” begins with a *device number* “000”, which is specifically assigned to each card specifically. The *device number* is passed to the driver to specify which device you wish to control. The *board ID* “No.2” is defined by on-board DIP switch SW1 that helps you identify each card in the PC.

If you want to test the card device further, go right to the next section on the *Device Testing*.

2.5 Device Testing

Following through the *Setup* and *Configuration* procedures to the last step described in the previous section, you can now proceed to test the device by clicking the **Test** Button on the *I/O Device Installation* dialog box (Fig. 2-11). A *Device Test* dialog box will appear accordingly:

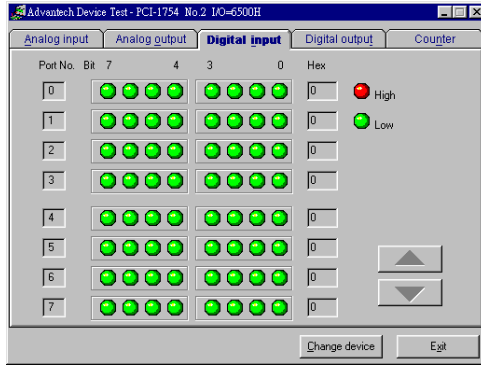



Fig. 2-12 PCI-1754 Digital Input tab on the Device Test dialog box
On the *Device Test* dialog box, users are free to test various functions of PCI-1754/1756 on the *Digital input* tab and of PCI-1752/1756 on the *Digital output* tab.

Note:

 You can access the *Device Test* dialog box either by the previous procedure for the Device Installation Program or simply by accessing **Start/Programs/Advantech Driver for 95 and 98 (or for NT) /Test Utility**.

Testing Digital Input Function (For PCI-1754/1756)

Click the *Digital Input* tab to show forth the *Digital Input* test panel as seen below. Through the color of the lamps, users can easily discern whether the status of each digital input channel is either high or low.

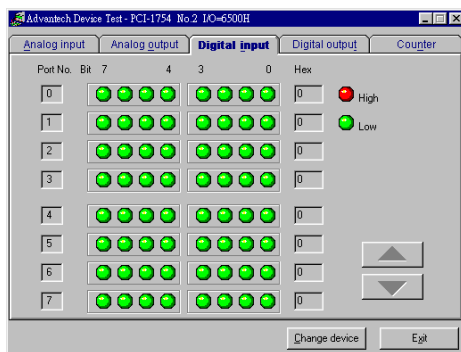

Fig. 2-13 PCI-1754 Digital Input tab on the Device Test dialog box

Testing Digital Output Function (For PCI-1752/1756)

Click the *Digital Output* tab to bring up the *Digital Output* test panel such as seen on the next page. By pressing the buttons on each tab, users can easily set each digital output channel as *high* or *low* for the corresponding port.

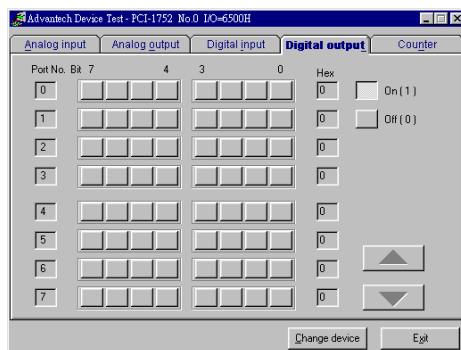

Fig. 2-14 PCI-1752 Digital Output tab on the Device Test dialog box

Only after your card device is properly set up, configured and tested, can the device installation procedure be counted as complete. After the device installation procedure is completed, you can now safely proceed to the next chapter, *Signal Connections*.

Chapter 2

3. Signal Connections

Maintaining signal connections is one of the most important factors in ensuring that your application system is sending and receiving data correctly. A good signal connection can avoid unnecessary and costly damage to your PC and other hardware devices. This chapter provides useful information about how to connect input and output signals to the PCI-1752/1754/1756 via the I/O connector.

3.1 I/O Connector Pin Assignment

The I/O connector on the PCI-1752/1754/1756 is a 100-pin connector that enable you to connect to accessories with the PCL-10250 shielded cable.

Figure 3-1, 3-2 and 3-3 show the pin assignments for the 100-pin I/O connector on the PCI-1752/1754/1756, and Table 3-1, 3-2 and 3-3 show their I/O connector signal description.

Note:

- ☞ The PCL-10250 shielded cable is especially designed for the PCI-1752/1754/1756 to reduce noise in the analog signal lines. Please refer to *Section 1.3 Accessories*.
-

3.2 Location of Jumpers and DIP switch

Figure 3-4, 3-5 and 3-6 show the names and locations of jumpers and DIP switch on the PCI-1752/1754/1756.

There are two jumpers, JP1 and JP2 on the PCI-1752/1756. Please refer to *Section 3.4 Isolated Digital Output Connection* and *Section 4.3 Channel-Freeze Function* for more information about JP1 and JP2 configurations.

IDO00 ~ IDO15 : Isolated digital output of Group 0

IDO16 ~ IDO31 : Isolated digital output of Group 1

IDO32 ~ IDO47 : Isolated digital output of Group 2

IDO48 ~ IDO63 : Isolated digital output of Group 3

PCOM0 : External common input of Group 0

PCOM1 : External common input of Group 1

PCOM2 : External common input of Group 2

PCOM3 : External common input of Group 3

IGND : Isolated ground

CH_FRZ_IN : Channel-Freeze input pin

CH_FRZ_COM : Common pin for Channel-Freeze input

IDO00	1	51	IDO01
IDO02	2	52	IDO03
IDO04	3	53	IDO05
IDO06	4	54	IDO07
IDO08	5	55	IDO09
IDO10	6	56	IDO11
IDO12	7	57	IDO13
IDO14	8	58	IDO15
PCOM0	9	59	PCOM0
PCOM0	10	60	PCOM0
IGND	11	61	IGND
IGND	12	62	IGND
IDO16	13	63	IDO17
IDO18	14	64	IDO19
IDO20	15	65	IDO21
IDO22	16	66	IDO23
IDO24	17	67	IDO25
IDO26	18	68	IDO27
IDO28	19	69	IDO29
IDO30	20	70	IDO31
PCOM1	21	71	PCOM1
PCOM1	22	72	PCOM1
IGND	23	73	IGND
IGND	24	74	IGND
CH_FRZ_IN	25	75	CH_FRZ_COM
IDO32	26	76	IDO33
IDO34	27	77	IDO35
IDO36	28	78	IDO37
IDO38	29	79	IDO39
IDO40	30	80	IDO41
IDO42	31	81	IDO43
IDO44	32	82	IDO45
IDO46	33	83	IDO47
PCOM2	34	84	PCOM2
PCOM2	35	85	PCOM2
IGND	36	86	IGND
IGND	37	87	IGND
IDO48	38	88	IDO49
IDO50	39	89	IDO51
IDO52	40	90	IDO53
IDO54	41	91	IDO55
IDO56	42	92	IDO57
IDO58	43	93	IDO59
IDO60	44	94	IDO61
IDO62	45	95	IDO63
PCOM3	46	96	PCOM3
PCOM3	47	97	PCOM3
IGND	48	98	IGND
IGND	49	99	IGND
CH_FRZ_IN	50	100	CH_FRZ_COM

Fig. 3-1 I/O Connector pin assignments for the PCI-1752

Signal Name	Reference	Direction	Description
IDO<00...15>	PCOM0	Output	Isolated digital output of group 0
IDO<16...31>	PCOM1	Output	Isolated digital output of group 1
IDO<32...47>	PCOM2	Output	Isolated digital output of group 2
IDO<48...63>	PCOM3	Output	Isolated digital output of group 3
PCOM0	-	Input	External common output of group 0
PCOM1	-	Input	External common output of group 1
PCOM2	-	Input	External common output of group 2
PCOM3	-	Input	External common output of group 3
IGND	-	-	Isolated ground
CH_FRZ_IN	CH_FRZ_COM	Input	Channel-Freeze function input pin
CH_FRZ_COM	-	Input	Common pin for Channel-Freeze function input

Table 3-1 PCI-1752 I/O Connector Signal Description

IDI00 ~ IDI15 : Isolated digital input of Group 0
 IDI16 ~ IDI31 : Isolated digital input of Group 1
 IDI32 ~ IDI47 : Isolated digital input of Group 2
 IDI48 ~ IDI63 : Isolated digital input of Group 3
 ECOM0 : External common input of Group 0
 ECOM1 : External common input of Group 1
 ECOM2 : External common input of Group 2
 ECOM3 : External common input of Group 3
 NC : No connection

IDI00	1	51	IDI01
IDI02	2	52	IDI03
IDI04	3	53	IDI05
IDI06	4	54	IDI07
IDI08	5	55	IDI09
IDI10	6	56	IDI11
IDI12	7	57	IDI13
IDI14	8	58	IDI15
ECOM0	9	59	ECOM0
ECOM0	10	60	ECOM0
NC	11	61	NC
NC	12	62	NC
IDI16	13	63	IDI17
IDI18	14	64	IDI19
IDI20	15	65	IDI21
IDI22	16	66	IDI23
IDI24	17	67	IDI25
IDI26	18	68	IDI27
IDI28	19	69	IDI29
IDI30	20	70	IDI31
ECOM1	21	71	ECOM1
ECOM1	22	72	ECOM1
NC	23	73	NC
NC	24	74	NC
NC	25	75	NC
IDI32	26	76	IDI33
IDI34	27	77	IDI35
IDI36	28	78	IDI37
IDI38	29	79	IDI39
IDI40	30	80	IDI41
IDI42	31	81	IDI43
IDI44	32	82	IDI45
IDI46	33	83	IDI47
ECOM2	34	84	ECOM2
ECOM2	35	85	ECOM2
NC	36	86	NC
NC	37	87	NC
IDI48	38	88	IDI49
IDI50	39	89	IDI51
IDI52	40	90	IDI53
IDI54	41	91	IDI55
IDI56	42	92	IDI57
IDI58	43	93	IDI59
IDI60	44	94	IDI61
IDI62	45	95	IDI63
ECOM3	46	96	ECOM3
ECOM3	47	97	ECOM3
NC	48	98	NC
NC	49	99	NC
NC	50	100	NC

Fig. 3-2 I/O connector pin assignments for the PCI-1754

Signal Name	Reference	Direction	Description
IDI<00...15>	ECOM0	Input	Isolated digital input of group 0
IDI<16...31>	ECOM1	Input	Isolated digital input of group 1
IDI<32...47>	ECOM2	Input	Isolated digital input of group 2
IDI<48...63>	ECOM3	Input	Isolated digital input of group 3
ECOM0	-	Input	External common input of group 0
ECOM1	-	Input	External common input of group 1
ECOM2	-	Input	External common input of group 2
ECOM3	-	Input	External common input of group 3
NC	-	-	No connection

Table 3-2 PCI-1754 I/O Connector Signal Description

Chapter 3

IDI00 ~ IDI15 : Isolated digital input of Group 0	IDI00	1	51	IDI01
	IDI02	2	52	IDI03
IDI16 ~ IDI31 : Isolated digital input of Group 1	IDI04	3	53	IDI05
	IDI06	4	54	IDI07
IDO00 ~ IDO15 : Isolated digital output of Group 0	IDI08	5	55	IDI09
	IDI10	6	56	IDI11
IDO16 ~ IDO31 : Isolated digital output of Group 1	IDI12	7	57	IDI13
	IDI14	8	58	IDI15
ECOM0 : External common input of Group 0	ECOM0	9	59	ECOM0
	ECOM0	10	60	ECOM0
ECOM1 : External common input of Group 1	NC	11	61	NC
	NC	12	62	NC
PCOM0 : External common output of Group 0	IDI16	13	63	IDI17
	IDI18	14	64	IDI19
PCOM1 : External common output of Group 1	IDI20	15	65	IDI21
	IDI22	16	66	IDI23
	IDI24	17	67	IDI25
	IDI26	18	68	IDI27
	IDI28	19	69	IDI29
	IDI30	20	70	IDI31
NC : No connection	ECOM1	21	71	PCOM1
	ECOM1	22	72	PCOM1
IGND : Isolated ground	NC	23	73	NC
	NC	24	74	NC
	NC	25	75	NC
CH_FRZ_IN : Channel-Freeze input pin	IDO00	26	76	IDO01
	IDO02	27	77	IDO03
CH_FRZ_COM : Common pin for Cannel-Freeze input	IDO04	28	78	IDO05
	IDO06	29	79	IDO07
	IDO08	30	80	IDO09
	IDO10	31	81	IDO11
	IDO12	32	82	IDO13
	IDO14	33	83	IDO15
	PCOM0	34	84	PCOM0
	PCOM0	35	85	PCOM0
	IGND	36	86	IGND
	IGND	37	87	IGND
	IDO16	38	88	IDO17
	IDO18	39	89	IDO19
	IDO20	40	90	IDO21
	IDO22	41	91	IDO23
	IDO24	42	92	IDO25
	IDO26	43	93	IDO27
	IDO28	44	94	IDO29
	IDO30	45	95	IDO31
	PCOM1	46	96	PCOM2
	PCOM1	47	97	PCOM2
	IGND	48	98	IGND
	IGND	49	99	IGND
	CH_FRZ_IN	50	100	CH_FRZ_COM

Fig. 3-3 I/O connector pin assignments for the PCI-1756

Signal Name	Reference	Direction	Description
IDI<00...15>	ECOM0	Input	Isolated digital input of group 0
IDI<16...31>	ECOM1	Input	Isolated digital input of group 1
IDO<00...15>	PCOM0	Output	Isolated digital output of group 2
IDO<16...31>	PCOM1	Output	Isolated digital output of group 3
ECOM0	-	Input	External common input of group 0
ECOM1	-	Input	External common input of group 1
PCOM0	-	Input	External common output of group 0
PCOM1	-	Input	External common output of group 1
IGND	-	-	Isolated ground
CH_FRZ_IN	CH_FRZ_COM	Input	Channel-Freeze function input pin
CH_FRZ_COM	-	Input	Common pin for Cannel-Freeze function input

Table 3-3 PCI-1756 I/O Connector Signal Description

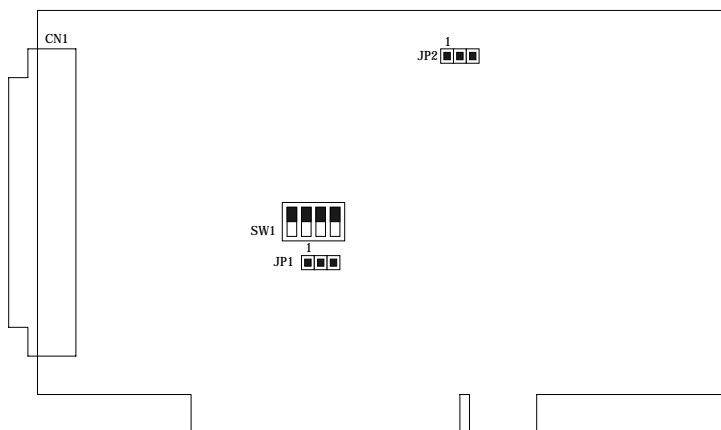

Fig. 3-4 Location of Jumpers and DIP switch on PCI-1752

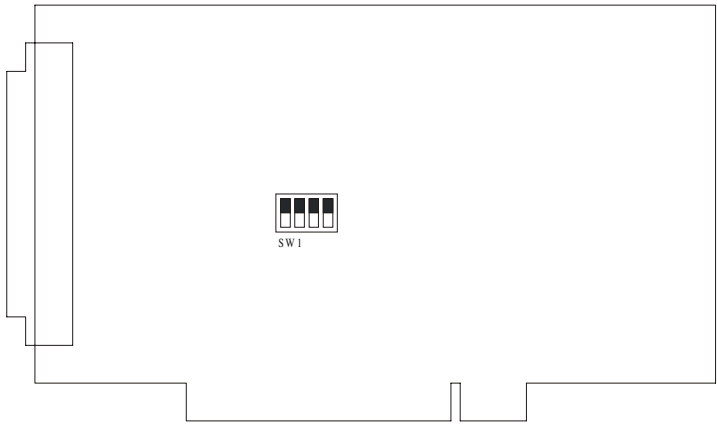

Fig. 3-5 Location of DIP switch on PCI-1754

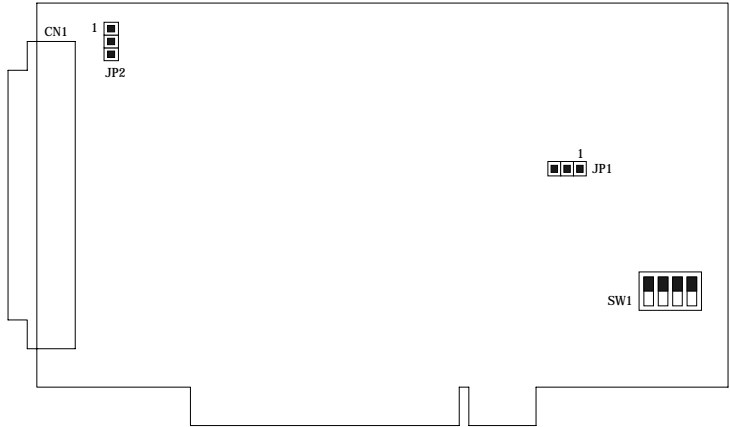

Fig. 3-6 Location of Jumpers and DIP switch on PCI-1756

3.3 Isolated Digital Input Connections

The PCI-1754 has 64 isolated digital input channels designated IDI00~IDI63, and PCI-1756 has 32 isolated digital input channels designated IDI00~IDI31.

Interrupt function of the DI signals

There are 4 channels (IDI00, IDI16, IDI32 and IDI48) in PCI-1754 and 2 channels (IDI00 and IDI16) in PCI-1756 can be used to generate hardware interrupts. A user can setup the configuration of interrupts by programming the interrupt control register. For detailed information, please refer to *Section 4.1 Interrupt Function*.

Isolated Inputs

Each of isolated digital input channel accepts 10~50 V_{DC} voltage inputs, and accept bi-directional input. It means that you can apply positive or negative voltage to an isolated input pin (V_{in}). Every 16 input channels share one common pins. Figure 3-7 shows how to connect an external input source to one of the card's isolated input channels

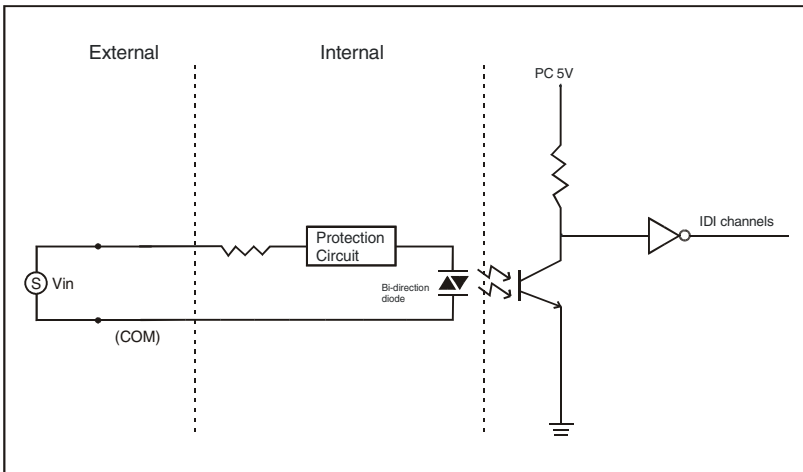

Fig. 3-7 Isolated digital input connection

3.4 Isolated Digital Output Connections

The PCI-1752 has 64 isolated digital output channels designated IDO00~IDO63, and PCI-1756 has 32 isolated digital output channels designated IDO00~IDO31.

Power On Configuration

Default configuration after power on, and hardware reset is to set all the isolated output channels to open status (the current of the load can't be sink) so that users need not worry about damaging external devices during system startup or reset.

When the system is hot reset, then the status of isolated digital output channels are selected by jumper JP1. Table 3-4 shows the configuration of jumper JP1.





PCI-1752 JP1	PCI-1756 JP1	Power on configuration after hot reset
1 	1 	Keep last status after hot reset
1 	1 	Default configuration

Table 3-4 JP1: Power on configuration after hot reset

Isolated Outputs

Each of isolated output channels comes equipped with a Darlington transistor. Every 16 output channels share common collectors and integral suppression diodes for inductive loads.

Note:

 If an external voltage (5 ~ 40 V_{DC}) is applied to an isolated output channel while it is being used as an output channel, the current will flow from the external voltage source to the card. Please take care that the current through each IDO pin not exceed 200 mA.

Figure 3-8 shows how to connect an external output load to the card's isolated outputs.

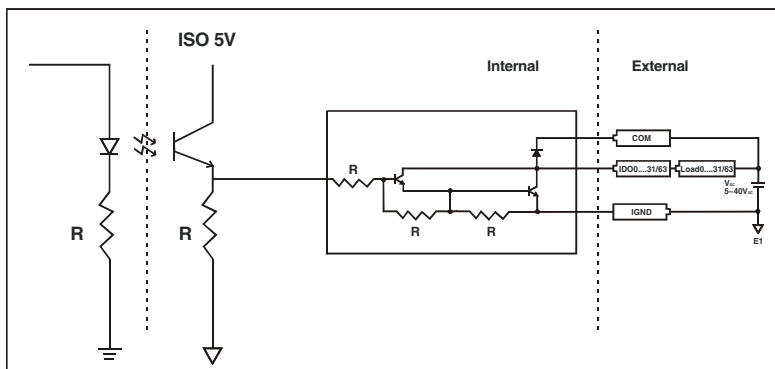

Fig. 3-8 Isolated Digital Output Connection

3.5 Field Wiring Considerations

When you use the PCI-1752/1754/1756 to acquire data from outside, noises in the environment might significantly affect the accuracy of your measurements if due cautions are not taken. The following measures will be helpful to reduce possible interference running signal wires between signal sources and the PCI-1752/1754/1756.

- The signal cables must be kept away from strong electromagnetic sources such as power lines, large electric motors, circuit breakers or welding machines, since they may cause strong electromagnetic interference. Keep the analog signal cables away from any video monitor, since it can significantly affect a data acquisition system.
- If the cable travels through an area with significant electromagnetic interference, you should adopt individually shielded, twisted-pair wires as the analog input cable. This type of cable has its signal wires twisted together and shielded with a metal mesh. The metal mesh should only be connected to one point at the signal source ground.
- Avoid running the signal cables through any conduit that might have power lines in it.
- If you have to place your signal cable parallel to a power line that has a high voltage or high current running through it, try to keep a safe distance between them. Or you should place the signal cable at a right angle to the power line to minimize the undesirable effect.

Chapter 3

- The signals transmitted on the cable will be directly affected by the quality of the cable. In order to ensure better signal quality, we recommend that you use the PCL-10250 shielded cable.

4. Operation

This chapter describes the operation of the PCI-1752/1754/1756. The software driver provided allows a user to access all of the card's functions without register level programming. For users who prefer to implement their own bit-level programming, please refer to the following information in this chapter.

4.1 Interrupt Function

The isolated digital input channels (IDI00, IDI16, IDI32 and IDI48 in PCI-1754; IDI00 and IDI16 in PCI-1756) are connected to the interrupt circuitry. Users can disable/enable interrupt function, select trigger type or latch the port data by setting the *Interrupt Control Register* of the PCI-1754/1756. When the interrupt request signals occur, then the software will service these interrupt requests by ISR. The multiple interrupt sources provide the card with more capability and flexibility.

IRQ Level

The IRQ level is set automatically by the PCI plug-and-play BIOS and is saved in the PCI controller. There is no need for users to set the IRQ level. Only one IRQ level is used by this card, although it has two or four interrupt sources.

Interrupt Control Register

The *Interrupt Control Register* controls the function and status of each interrupt signal source. Table 4-1 shows the bit map of the *Interrupt Control Register*. The register is a readable/writable register. While being written, it is used as a control register; and while being read, it is used as a status register.

	Group n interrupt control register			
Base Add.+8+2n	3	2	1	0
Abbreviation	Fn	En	INTn/E	Ln/E

Table 4-1 Interrupt control register bit map

n: the group's number

Ln/E: Latch port data disable/enable control bit

INTn/E: Interrupt disable/enable control bit

En: Interrupt triggering edge control bit

Fn: Interrupt flag bit

Latch Port Data Function

The function enables you to latch the last data of each associated digital input channels when the interrupt occurs and you can free the latch function by clearing interrupt. We have organized every 16 bits into one group. When the Latch Port Data Function is enabled for a specific group, the values of all channel ports in this group will be latched. The function is determined by the value in the *latch port data disable/enable control* bit in the interrupt control register, as shown in Table 4-2.

Ln/E	Latch port data when the interrupt occurs
0	Disable
1	Enable

Table 4-2 Latch port data disable/enable control bit

Interrupt Enable Control Function

The user can choose to enable or disable the interrupt function by writing its corresponding value to the *interrupt disable/enable control* bit in the *interrupt control register*, as shown in Table 4-3.

INTn/E	Interrupt control
0	Disable
1	Enable

Table 4-3 Interrupt disable/enable control bit values

Interrupt Triggering Edge Control

The interrupt can be triggered by a rising edge or a falling edge of the interrupt signal, as determined by the value in the *interrupt triggering edge control* bit in the interrupt control register, as shown in Table 4-4.

En	Triggering edge of interrupt signal
0	Falling edge trigger
1	Rising edge trigger

Table 4-4 Interrupt triggering edge control bit values

Interrupt Flag Bit

The *interrupt flag* bit is a flag indicating the status of an interrupt. It is a readable/writable bit. To find the status of the interrupt, you have to read the bit value; to clear the interrupt, you have to write “1” to this bit. This bit must first be cleared to service the next incoming interrupt.

Fn		Interrupt status
Read	0	No interrupt
	1	Interrupt occur
Write	0	Don't care
	1	Clear interrupt

Table 4-5 Interrupt flag bit values

4.2 Board ID

The PCI-1752/1754/1756 has a built-in DIP switch (SW1), which is used to define each card's board ID. You can determine the board ID on the register as shown on Table 4-6. When there are multiple cards on the same chassis, this board ID setting function is useful for identifying each card's device number through board ID. We set the PCI-1752/1754/1756 board ID as 0 at the factory. If you need to adjust it to other board ID, set the SW1 by referring to the Table 4-7.

Base Add.+10 _h	Board ID register			
	3	2	1	0
Abbreviation	ID3	ID2	ID1	ID0

Table 4-6 Board ID register

ID0: the least significant bit (LSB) of Board ID

ID3: the most significant bit (MSB) of Board ID

Board ID setting (SW1)				
Board ID(dec)	Switch Position			
	3	2	1	0
*0	●	●	●	●
1	●	●	●	○
:				
14	○	○	○	●
15	○	○	○	○

○ = Off ● = On * = default

Table 4-7 Board ID setting

There are two ways to make association of the device number with the corresponding board ID. The first way is to check the content in *I/O Device Installation Dialog Box*, as shown in Fig. 4-1. The second way is to determine the board ID by its device number through DLL function, *DRV_DeviceGetFeatures()*. For detailed information, please refer to software manual on CD-ROM.

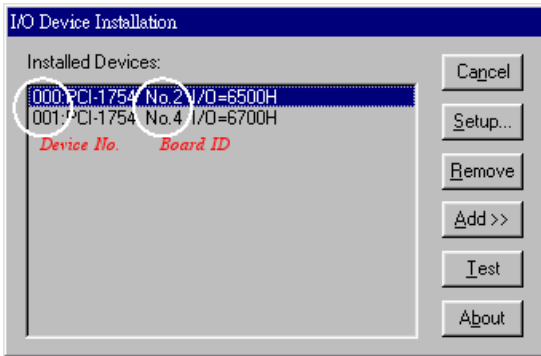

Fig. 4-1 The device No. and board ID on dialog box

4.3 Channel-Freeze Function

The PCI-1752/1756 provides the channel-freeze function for isolated digital output channels. When *Channel-Freeze* function is enabled, all ports on the card will be locked so that the data transmitted (from the host PC) to the card won't be transferred to the DO ports. Once the *Channel-Freeze* function is enabled, each port status is immediately

frozen into its last valid value before the *Channel-Freeze*. Since the value transmitted (from the host PC) to the card is also stored in the buffers on PC, thus when user calls the *DRV_DioGetCurrentDOByte ()* function to read back the DO channel value, this function will determine that:

If Channel-Freeze function is disabled, it will return the DO value on the port;

If Channel-Freeze function is enabled, it will return the value from the buffers on host PC.

The PCI-1752 provides digital input channel (CH_FRZ_IN) to enable channel-freeze function, and PCI-1756 provides one input channel. The channel-freeze function acts when the pin CH_FRZ_IN is activated. Moreover, you can setup the input mode of channel-freeze function input channel CH_FRZ_IN as dry contact input mode or wet contact input mode selected by on-board jumper JP2, as shown in Table 4-8. The wiring in wet contact and dry contact input mode are shown in Figure 4-2. Otherwise, you also can enable the function through software by writing “1” to CFC (Channel-Freeze Function Control) bit on channel-freeze function register, as shown in Table 4-9 and Table 4-10. It’s useful in software simulation and testing program.

The CFS (Channel-Freeze Function Status) bit shows the status of Channel-Freeze function:

A value of 1 for the CFS bit indicates an active Channel-Freeze Function; whereas a value of 0 indicates a non-active Channel-Freeze Function.





PCI-1752 JP2	PCI-1756 JP2	Input mode
<p>1</p> 	 <p>1</p>	Dry contact input mode
<p>1</p> 	 <p>1</p>	Wet contact input mode(Default setting)

Table 4-8 JP2: Channel-Freeze function input mode

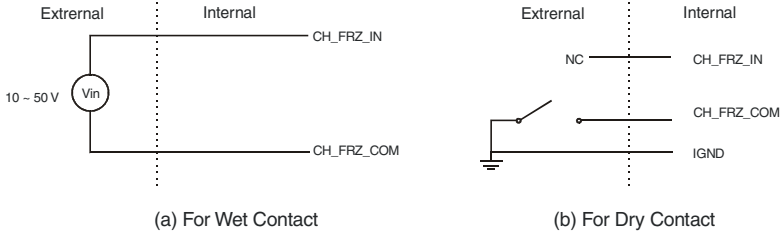

Fig. 4-2 The wiring in wet/dry contact input mode

Channel-Freeze function register				
Base Add.+12 _n	3	2	1	0
Abbreviation			CFS	CFC

Table 4-9 Channel-Freeze function register

CFC	Channel-Freeze function control
0	Disable
1	Enable
CFS	Channel-Freeze function status
0	OFF
1	ON

Table 4-10 Channel-Freeze function bit value

Specifications

Isolated Digital Input (PCI-1754/1756)

Number of Input Channel	PCI-1754	64
	PCI-1756	32
Interrupt Inputs	PCI-1754	4 (IDI0, IDI16, IDI32, IDI48)
	PCI-1756	2 (IDI0, IDI16)
Optical Isolation	2500 V _{DC}	
Opto-isolator response time	25 μs	
Over-voltage Protect	70 V _{DC}	
ESD	2,000 V _{DC}	
Input Voltage	V _{IH} (max.)	50 V _{DC}
	V _{IH} (min.)	10 V _{DC}
	V _{IL} (max.)	3 V _{DC}
Input Current	10 V _{DC}	1.70 mA (typical)
	12 V _{DC}	2.10 mA (typical)
	24 V _{DC}	4.40 mA (typical)
	48 V _{DC}	9.00 mA (typical)
	50 V _{DC}	9.40 mA (typical)

Isolated Digital Output (PCI-1752/1756)

Number of Output Channel	PCI-1752	64
	PCI-1756	32
Optical Isolation	2500 V _{DC}	
Opto-isolator response time	25μs	
Supply Voltage	5 ~ 40 V _{DC}	
Sink Current	200 mA max/channel	

General (PCI-1752/1754/1756)

I/O Connector Type	100-pin SCSI-II female	
Dimensions	175 mm x 100 mm (6.9" x 3.9")	
Power Consumption	PCI-1752	+5V @ 230 mA (typical)
		+5V @ 500 mA (max.)
	PCI-1754	+5V @ 340 mA (typical)
		+5V @ 450 mA (max.)
	PCI-1756	+5V @ 285 mA (typical)
		+5V @ 475 mA (max.)
Temperature	Operation	0 ~ +60° C (32 ~ 140° F) (refer to IEC 68-2-1,2)
	Storage	-20 ~ +70° C (-4 ~ 158° F)
Relative Humidity	5 - 95 % RH non-condensing (refer to IEC 68-2-3)	
Certification	CE Class A certified	

Block Diagram

PCI-1752 Block Diagram

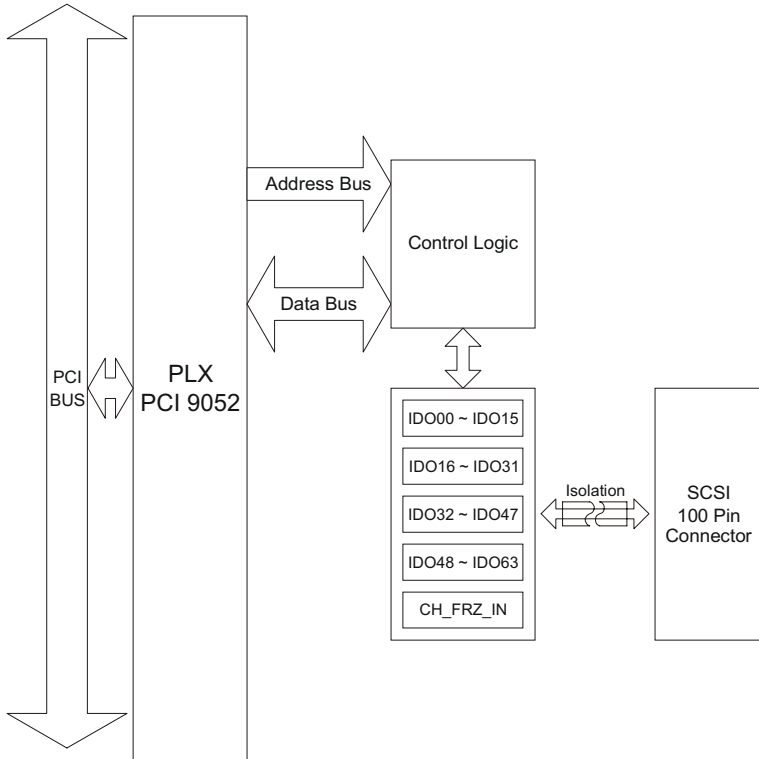

PCI-1754 Block Diagram

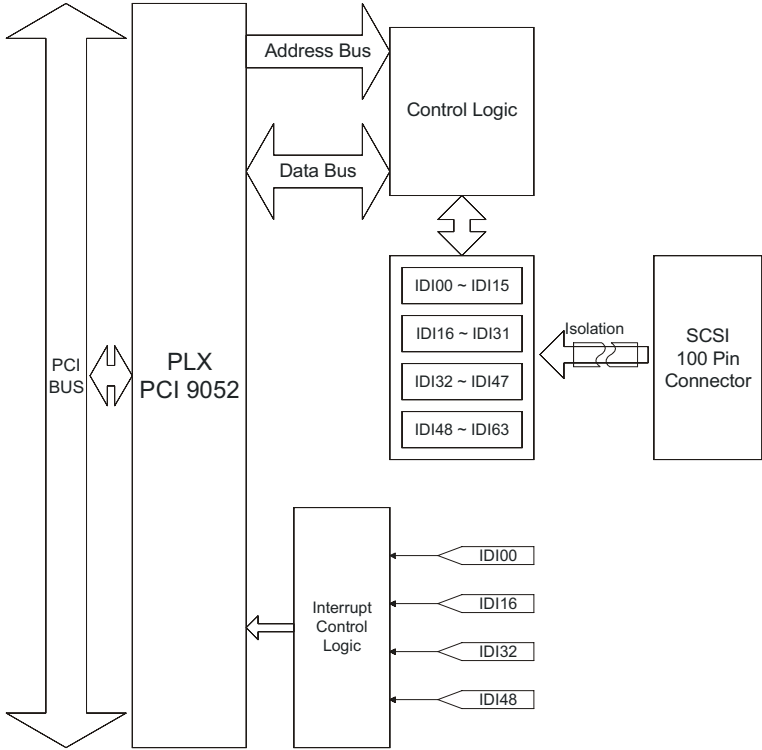

PCI-1756 Block Diagram

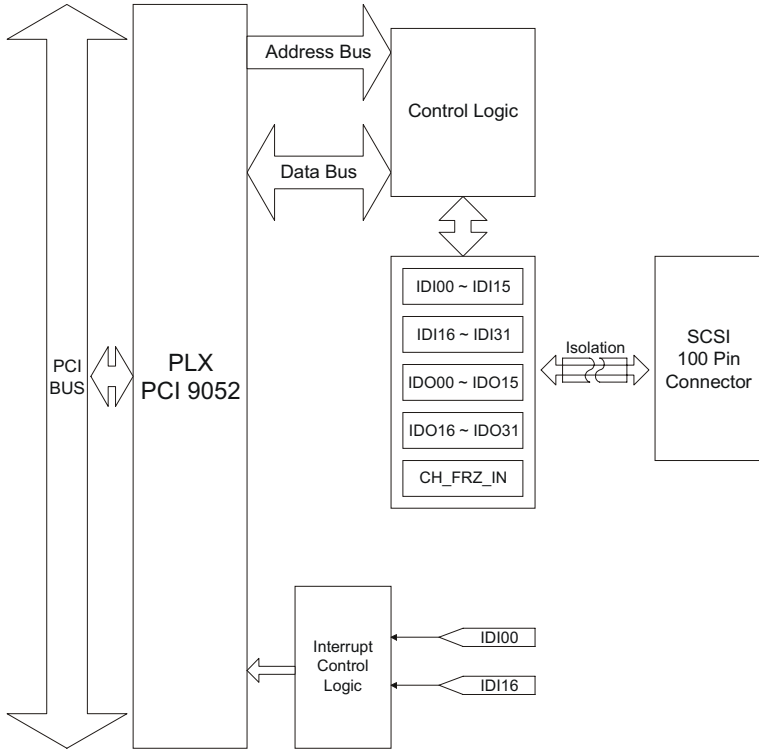

Register Structure and Format

C.1 Overview

The PCI-1752/1754/1756 is delivered with an easy-to-use 32-bit DLL driver for user programming under the Windows 95/98/NT operating system. We advise users to program the PCI-1752/1754/1756 using the 32-bit DLL driver provided by Advantech to avoid the complexity of low-level programming by register.

The most important consideration in programming the PCI-1752/1754/1756 at the register level is to understand the function of the card's registers. The information in the following sections is provided only for users who would like to do their own low-level programming.

C.2 I/O Port Address Map

The PCI-1752/1754/1756 requires 32 consecutive addresses in the PC's I/O space. The address of each register is specified as an offset from the card's base address. For example, BASE+0 is the card's base address and BASE+7 is the base address plus seven bytes.

C.3 PCI-1752 Register Format

PCI-1752 Register Format																
Base Add.	15	14	13	12	11	10	9	8	7	6	5	4	3	2	1	0
0	R	Digital Output Group 0 Read Back														
		DO15	DO14	DO13	DO12	DO11	DO10	DO9	DO8	DO7	DO6	DO5	DO4	DO3	DO2	DO1
0	W	Digital Output Group 1														
		DO15	DO14	DO13	DO12	DO11	DO10	DO9	DO8	DO7	DO6	DO5	DO4	DO3	DO2	DO1
2	R	Digital Output Group 1 Read Back														
		DO31	DO30	DO29	DO28	DO27	DO26	DO25	DO24	DO23	DO22	DO21	DO20	DO19	DO18	DO17
2	W	Digital Output Group 1														
		DO31	DO30	DO29	DO28	DO27	DO26	DO25	DO24	DO23	DO22	DO21	DO20	DO19	DO18	DO17
4	R	Digital Output Group 2 Read Back														
		DO47	DO46	DO45	DO44	DO43	DO42	DO41	DO40	DO39	DO38	DO37	DO36	DO35	DO34	DO33
4	W	Digital Output Group 2														
		DO47	DO46	DO45	DO44	DO43	DO42	DO41	DO40	DO39	DO38	DO37	DO36	DO35	DO34	DO33
6	R	Digital Output Group 3 Read Back														
		DO63	DO62	DO61	DO60	DO59	DO58	DO57	DO56	DO55	DO54	DO53	DO52	DO51	DO50	DO49
6	W	Digital Output Group 3														
		DO63	DO62	DO61	DO60	DO59	DO58	DO57	DO56	DO55	DO54	DO53	DO52	DO51	DO50	DO49
8	R	N/A														
8	W	N/A														
A	R	N/A														
A	W	N/A														
10	R	Board ID Register										ID3	ID2	ID1	ID0	
		N/A														
10	W															
12	R	Channel-Freeze Function Control Register										CFS		CFC		
12	W	Channel-Freeze Function Status Register												CFC		

C.4 PCI-1754 Register Format

PCI-1754 Register Format																
Base Add.	15	14	13	12	11	10	9	8	7	6	5	4	3	2	1	0
0	R	Digital Input Group 0														
	W	DI15	DI14	DI13	DI12	DI11	DI10	DI9	DI8	DI7	DI6	DI5	DI4	DI3	DI2	DI1
2	R	Digital Input Group 1														
	W	DI31	DI30	DI29	DI28	DI27	DI26	DI25	DI24	DI23	DI22	DI21	DI20	DI19	DI18	DI17
4	R	Digital Input Group 2														
	W	DI47	DI46	DI45	DI44	DI43	DI42	DI41	DI40	DI39	DI38	DI37	DI36	DI35	DI34	DI33
6	R	Digital Input Group 3														
	W	DI63	DI62	DI61	DI60	DI59	DI58	DI57	DI56	DI55	DI54	DI53	DI52	DI51	DI50	DI49
8	R	Group 0 Interrupt Control Register														
	W												F0	E0	INT0/E	L0/E
A	R	Group 1 Interrupt Control Register														
	W												F1*	E1	INT1/E	L1/E
C	R	Group 2 Interrupt Control Register														
	W												F2*	E2	INT2/E	L2/E
E	R	Group 3 Interrupt Control Register														
	W												F3*	E3	INT3/E	L3/E
10	R	Board ID Register														
	W												ID3	ID2	ID1	ID0
		N/A														

Note: Write “1” to the bit Fn in Interrupt Control Register clears the interrupt

C.5 PCI-1756 Register Format

PCI-1756 Register Format																	
Base Add.	15	14	13	12	11	10	9	8	7	6	5	4	3	2	1	0	
0	R	Digital Input Group 0															
		DI15	DI14	DI13	DI12	DI11	DI10	DI9	DI8	DI7	DI6	DI5	DI4	DI3	DI2	DI1	DI0
	W	N/A															
2	R	Digital Input Group 1															
		DI31	DI30	DI29	DI28	DI27	DI26	DI25	DI24	DI23	DI22	DI21	DI20	DI19	DI18	DI17	DI16
	W	N/A															
4	R	Digital Output Group 0 Read Back															
		DO15	DO14	DO13	DO12	DO11	DO10	DO9	DO8	DO7	DO6	DO5	DO4	DO3	DO2	DO1	DO0
	W	Digital Output Group 0															
		DO15	DO14	DO13	DO12	DO11	DO10	DO9	DO8	DO7	DO6	DO5	DO4	DO3	DO2	DO1	DO0
6	R	Digital Output Group 1 Read Back															
		DO31	DO30	DO29	DO28	DO27	DO26	DO25	DO24	DO23	DO22	DO21	DO20	DO19	DO18	DO17	DO16
	W	Digital Output Group 1															
		DO31	DO30	DO29	DO28	DO27	DO26	DO25	DO24	DO23	DO22	DO21	DO20	DO19	DO18	DO17	DO16
8	R	Group 0 Interrupt Control Register															
														F0	E0	INT0/E	L0/E
	W	Group 0 Interrupt Control Register															
														F0*	E0	INT0/E	L0/E
A	R	Group 1 Interrupt Control Register															
														F1	E1	INT1/E	L1/E
	W	Group 1 Interrupt Control Register															
														F1*	E1	INT1/E	L1/E
10	R	Board ID Register															
														ID3	ID2	ID1	ID0
	W	N/A															
12	R	Channel-Freeze Function Control Register															
														CFS	CFC		
	W	Channel-Freeze Function Status Register															
															CFC		

Note: Write “1” to the bit Fn in Interrupt Control Register clears the interrupt

ADAM-3951 Pin Assignment

ADAM-3951 Pin Assignment General Form

SCSI-II 50-pin Connector

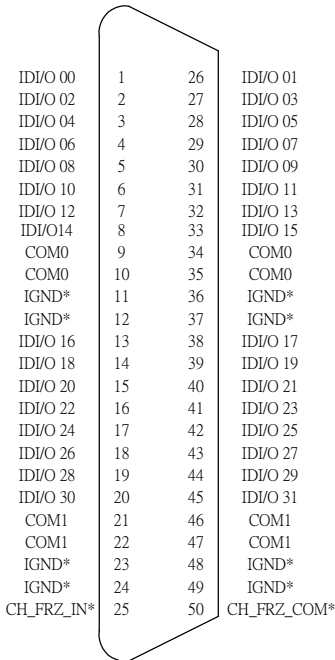



















































*: The pins defined for PCI-1752/1756

TB1		TB2	
1	IDI/O 00	26	IDI/O 16
2	IDI/O 01	27	IDI/O 17
3	IDI/O 02	28	IDI/O 18
4	IDI/O 03	29	IDI/O 19
5	IDI/O 04	30	IDI/O 20
6	IDI/O 05	31	IDI/O 21
7	IDI/O 06	32	IDI/O 22
8	IDI/O 07	33	IDI/O 23
9	IDI/O 08	34	IDI/O 24
10	IDI/O 09	35	IDI/O 25
11	IDI/O 10	36	IDI/O 26
12	IDI/O 11	37	IDI/O 27
13	IDI/O 12	38	IDI/O 28
14	IDI/O 13	39	IDI/O 29
15	IDI/O 14	40	IDI/O 30
16	IDI/O 15	41	IDI/O 31
17	COM0	42	COM1
18	COM0	43	COM1
19	COM0	44	COM1
20	COM0	45	COM1
21	IGND*	46	IGND*
22	IGND*	47	IGND*
23	IGND*	48	IGND*
24	IGND*	49	IGND*
25	CH_FRZ_IN*	50	CH_FRZ_COM*

PCI-1752 Connects with ADAM-3951

Connect with PCL-10250 CON1

TB1			TB2		
1		IDO 00	26		IDO 16
2		IDO 01	27		IDO 17
3		IDO 02	28		IDO 18
4		IDO 03	29		IDO 19
5		IDO 04	30		IDO 20
6		IDO 05	31		IDO 21
7		IDO 06	32		IDO 22
8		IDO 07	33		IDO 23
9		IDO 08	34		IDO 24
10		IDO 09	35		IDO 25
11		IDO 10	36		IDO 26
12		IDO 11	37		IDO 27
13		IDO 12	38		IDO 28
14		IDO 13	39		IDO 29
15		IDO 14	40		IDO 30
16		IDO 15	41		IDO 31
17		PCOM0	42		PCOM1
18		PCOM0	43		PCOM1
19		PCOM0	44		PCOM1
20		PCOM0	45		PCOM1
21		IGND	46		IGND
22		IGND	47		IGND
23		IGND	48		IGND
24		IGND	49		IGND
25		CH_FRZ_IN	50		CH_FRZ_COM

Connect with PCL-10250 CON2



















































TB1		TB2			
1	⊖	IDO 32	26	⊖	IDO 48
2	⊖	IDO 33	27	⊖	IDO 49
3	⊖	IDO 34	28	⊖	IDO 50
4	⊖	IDO 35	29	⊖	IDO 51
5	⊖	IDO 36	30	⊖	IDO 52
6	⊖	IDO 37	31	⊖	IDO 53
7	⊖	IDO 38	32	⊖	IDO 54
8	⊖	IDO 39	33	⊖	IDO 55
9	⊖	IDO 40	34	⊖	IDO 56
10	⊖	IDO 41	35	⊖	IDO 57
11	⊖	IDO 42	36	⊖	IDO 58
12	⊖	IDO 43	37	⊖	IDO 59
13	⊖	IDO 44	38	⊖	IDO 60
14	⊖	IDO 45	39	⊖	IDO 61
15	⊖	IDO 46	40	⊖	IDO 62
16	⊖	IDO 47	41	⊖	IDO 63
17	⊖	PCOM2	42	⊖	PCOM3
18	⊖	PCOM2	43	⊖	PCOM3
19	⊖	PCOM2	44	⊖	PCOM3
20	⊖	PCOM2	45	⊖	PCOM3
21	⊖	IGND	46	⊖	IGND
22	⊖	IGND	47	⊖	IGND
23	⊖	IGND	48	⊖	IGND
24	⊖	IGND	49	⊖	IGND
25	⊖	CH_FRZ_IN	50	⊖	CH_FRZ_COM

PCI-1754 Connects with ADAM-3951

Connect with PCL-10250 CON1

TB1			TB2		
1	⊞	IDI 00	26	⊞	IDI 16
2	⊞	IDI 01	27	⊞	IDI 17
3	⊞	IDI 02	28	⊞	IDI 18
4	⊞	IDI 03	29	⊞	IDI 19
5	⊞	IDI 04	30	⊞	IDI 20
6	⊞	IDI 05	31	⊞	IDI 21
7	⊞	IDI 06	32	⊞	IDI 22
8	⊞	IDI 07	33	⊞	IDI 23
9	⊞	IDI 08	34	⊞	IDI 24
10	⊞	IDI 09	35	⊞	IDI 25
11	⊞	IDI 10	36	⊞	IDI 26
12	⊞	IDI 11	37	⊞	IDI 27
13	⊞	IDI 12	38	⊞	IDI 28
14	⊞	IDI 13	39	⊞	IDI 29
15	⊞	IDI 14	40	⊞	IDI 30
16	⊞	IDI 15	41	⊞	IDI 31
17	⊞	ECOM0	42	⊞	ECOM1
18	⊞	ECOM0	43	⊞	ECOM1
19	⊞	ECOM0	44	⊞	ECOM1
20	⊞	ECOM0	45	⊞	ECOM1
21	⊞	NC	46	⊞	NC
22	⊞	NC	47	⊞	NC
23	⊞	NC	48	⊞	NC
24	⊞	NC	49	⊞	NC
25	⊞	NC	50	⊞	NC

Connect with PCL-10250 CON2

TB1		TB2			
1		IDI 32	26		IDI 48
2		IDI 33	27		IDI 49
3		IDI 34	28		IDI 50
4		IDI 35	29		IDI 51
5		IDI 36	30		IDI 52
6		IDI 37	31		IDI 53
7		IDI 38	32		IDI 54
8		IDI 39	33		IDI 55
9		IDI 40	34		IDI 56
10		IDI 41	35		IDI 57
11		IDI 42	36		IDI 58
12		IDI 43	37		IDI 59
13		IDI 44	38		IDI 60
14		IDI 45	39		IDI 61
15		IDI 46	40		IDI 62
16		IDI 47	41		IDI 63
17		ECOM2	42		ECOM3
18		ECOM2	43		ECOM3
19		ECOM2	44		ECOM3
20		ECOM2	45		ECOM3
21		NC	46		NC
22		NC	47		NC
23		NC	48		NC
24		NC	49		NC
25		NC	50		NC

PCI-1756 Connects with ADAM-3951

Connect with PCL-10250 CON1

TB1			TB2		
1	⓪	IDI 00	26	⓪	IDI 16
2	⓪	IDI 01	27	⓪	IDI 17
3	⓪	IDI 02	28	⓪	IDI 18
4	⓪	IDI 03	29	⓪	IDI 19
5	⓪	IDI 04	30	⓪	IDI 20
6	⓪	IDI 05	31	⓪	IDI 21
7	⓪	IDI 06	32	⓪	IDI 22
8	⓪	IDI 07	33	⓪	IDI 23
9	⓪	IDI 08	34	⓪	IDI 24
10	⓪	IDI 09	35	⓪	IDI 25
11	⓪	IDI 10	36	⓪	IDI 26
12	⓪	IDI 11	37	⓪	IDI 27
13	⓪	IDI 12	38	⓪	IDI 28
14	⓪	IDI 13	39	⓪	IDI 29
15	⓪	IDI 14	40	⓪	IDI 30
16	⓪	IDI 15	41	⓪	IDI 31
17	⓪	ECOM0	42	⓪	ECOM1
18	⓪	ECOM0	43	⓪	ECOM1
19	⓪	ECOM0	44	⓪	ECOM1
20	⓪	ECOM0	45	⓪	ECOM1
21	⓪	NC	46	⓪	NC
22	⓪	NC	47	⓪	NC
23	⓪	NC	48	⓪	NC
24	⓪	NC	49	⓪	NC
25	⓪	NC	50	⓪	NC

Connects with PCL-10250 CON2

TB1		TB2			
1	⊖	IDO 00	26	⊖	IDO 16
2	⊖	IDO 01	27	⊖	IDO 17
3	⊖	IDO 02	28	⊖	IDO 18
4	⊖	IDO 03	29	⊖	IDO 19
5	⊖	IDO 04	30	⊖	IDO 20
6	⊖	IDO 05	31	⊖	IDO 21
7	⊖	IDO 06	32	⊖	IDO 22
8	⊖	IDO 07	33	⊖	IDO 23
9	⊖	IDO 08	34	⊖	IDO 24
10	⊖	IDO 09	35	⊖	IDO 25
11	⊖	IDO 10	36	⊖	IDO 26
12	⊖	IDO 11	37	⊖	IDO 27
13	⊖	IDO 12	38	⊖	IDO 28
14	⊖	IDO 13	39	⊖	IDO 29
15	⊖	IDO 14	40	⊖	IDO 30
16	⊖	IDO 15	41	⊖	IDO 31
17	⊖	PCOM0	42	⊖	PCOM1
18	⊖	PCOM0	43	⊖	PCOM1
19	⊖	PCOM0	44	⊖	PCOM1
20	⊖	PCOM0	45	⊖	PCOM1
21	⊖	IGND	46	⊖	IGND
22	⊖	IGND	47	⊖	IGND
23	⊖	IGND	48	⊖	IGND
24	⊖	IGND	49	⊖	IGND
25	⊖	CH_FRZ_IN	50	⊖	CH_FRZ_COM

警告使用者

這是甲類的資訊產品，在居住的環境中使用時，可能會造成射頻干擾，在這種情況下，使用者會被要求採取某些適當的對策。