

OPTOIO-PCI32 STANDARD

EDP No.: A-440600

32 optocoupler isolated digital inputs
32 optocoupler isolated digital outputs

wasco[®]

user's guide

Copyright© 2002-2011 by Messcomp Datentechnik GmbH

This documentation is copyright by Messcomp Datentechnik GmbH. All rights are reserved.

Messcomp Datentechnik GmbH reserves the right to modify the products described in this manual at any time and without preannouncement.

No parts of this manual are allowed to be reproduced, copied, translated or transmitted in any way without a prior written consent of Messcomp Datentechnik GmbH.

Registered Trademarks

IBM PC, PC/XT and PC/AT are registered trademarks of International Business Machines (IBM).

BASIC is registered trademark of Dartmouth College.

Turbo Pascal, Turbo C are registered trademarks of Borland.

Quickbasic is registered trademark of Microsoft.

Powerbasic is registered trademark of Robert S. Zale.

wasco® is registered trademark.

Disclaimer

The company Messcomp Datentechnik GmbH assumes no liability for the use of the interface card OPTOIO-PCI32_{STANDARD} and this documentation, neither for direct nor indirect damages.

Table of Contents

- 1. Description**
- 2. Installation of the OPTOIO-PCI32^{STANDARD}**
 - 2.1 Installing the card into your system
- 3. Connectors**
 - 3.1 Position of the connector plugs on the board
 - 3.2 Pin assignment of CN1
 - 3.3 Pin assignment of CN2
- 4. System Components**
 - 4.1 Block diagram
 - 4.2 Access to the system components
- 5. 32 Optocoupler Isolated Digital Inputs**
 - 5.1 Pin assignment of the input optocoupler
 - 5.2 Input voltage ranges
- 6. 32 Optocoupler Isolated Digital Outputs**
 - 6.1 Pin assignment of the output optocouplers
 - 6.2 Optocoupler specification
- 7. Programmierung unter DOS[®]**
 - 7.1 Programming of the OPTOIO-PCI32
 - 7.2 Allocation of the port addresses
- 8. Programmierung unter Windows[®]**
 - 8.1 Programming of the OPTOIO-PCI32
 - 8.2 Installation of Windows[®] drivers
- 9. Accessories**
 - 9.1 Suitable **wasco**[®] accessories
 - 9.2 Connecting technique (samples)
 - 9.3 Single components for own assembly

10. Troubleshooting

11 Specifications

12. Product Liability Act

13. CE Declaration of Conformity

1. Description

The **wasco**[®] interface card OPTOIO-PCI32_{STANDARD} provides 32 digital inputs and 32 digital outputs, every single channel is at input or output galvanically isolated by optocouplers of high quality. All input optocouplers are fitted out with integrated schmitt trigger function. Special high power output optocouplers negotiate a switching current of up to 150 mA.

Each input or output is protected by additional protection diodes against harmful voltage peaks. You can adjust two different voltage ranges for each single input channel by resistor arrays easily to set.

Two 68-pin SCSI-II jacks enable to connect periphery to the OPTOIO-PCI32_{STANDARD}. The signals of the output optocouplers are led to one 68-pin SCSI jack mounted to the board's slot bracket. Connections of the input optocouplers are led to the second SCSI-II jack mounted directly on the board. On demand a special cable (set of female connector, ribbon cable and 68-pin female connector with slot bracket) is available to postpone the connection to a slot of your PC's casing.

2. Installation of the OPTOIO-PCI32_{STANDARD}

2.1 Installation of the card into your system

Before you insert the card unplug the power cord or make sure, there is no current to/in the computer. Inserting into a running system may cause damaging or destroying not only OPTOIO-PCI32_{STANDARD}, but even other already inserted cards of your computer.

Select an empty PCI slot of your computer for inserting the card. Please refer to the computer's manual for support. Secure the OPTOIO-PCI32 by screwing the mounting bracket to your computer's casing to avoid a card's loosening by effects of the cables.

3. Connectors

3.1 Position of the connector plugs

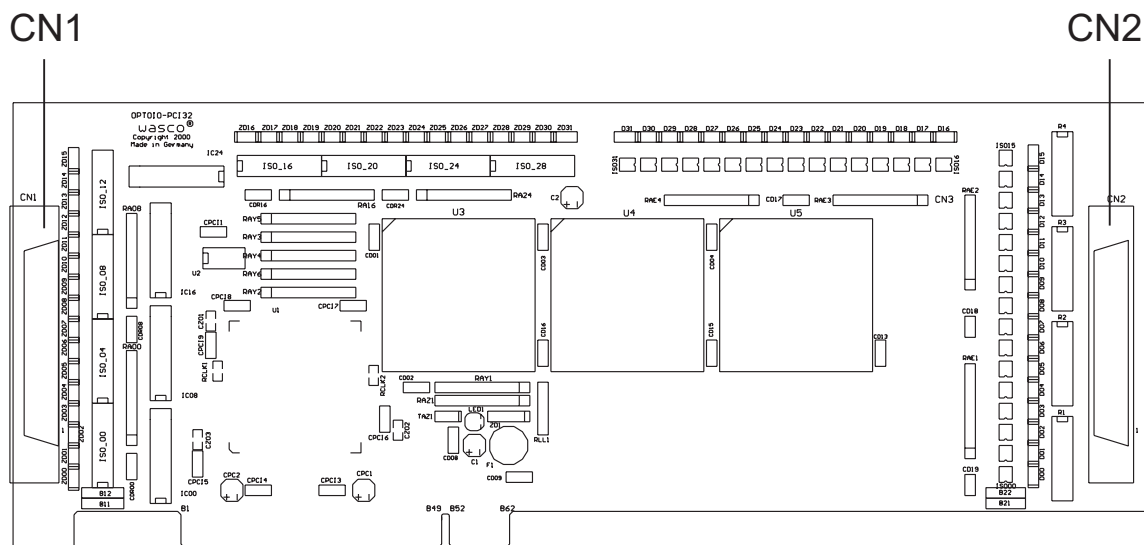

CN1: Optocoupler Outputs OUT00...OUT31

CN2: Optocoupler Inputs IN00...IN31

3.2 Pin assignment of CN1

GND	68	□	□	34	Vcc
GND	67	□	□	33	Vcc
OUT31-	66	□	□	32	OUT31+
OUT30-	65	□	□	31	OUT30+
OUT29-	64	□	□	30	OUT29+
OUT28-	63	□	□	29	OUT28+
OUT27-	62	□	□	28	OUT27+
OUT26-	61	□	□	27	OUT26+
OUT25-	60	□	□	26	OUT25+
OUT24-	59	□	□	25	OUT24+
OUT23-	58	□	□	24	OUT23+
OUT22-	57	□	□	23	OUT22+
OUT21-	56	□	□	22	OUT21+
OUT20-	55	□	□	21	OUT20+
OUT19-	54	□	□	20	OUT19+
OUT18-	53	□	□	19	OUT18+
OUT17-	52	□	□	18	OUT17+
OUT16-	51	□	□	17	OUT16+
OUT15-	50	□	□	16	OUT15+
OUT14-	49	□	□	15	OUT14+
OUT13-	48	□	□	14	OUT13+
OUT12-	47	□	□	13	OUT12+
OUT11-	46	□	□	12	OUT11+
OUT10-	45	□	□	11	OUT10+
OUT09-	44	□	□	10	OUT09+
OUT08-	43	□	□	9	OUT08+
OUT07-	42	□	□	8	OUT07+
OUT06-	41	□	□	7	OUT06+
OUT05-	40	□	□	6	OUT05+
OUT04-	39	□	□	5	OUT04+
OUT03-	38	□	□	4	OUT03+
OUT02-	37	□	□	3	OUT02+
OUT01-	36	□	□	2	OUT01+
OUT00-	35	□	□	1	OUT00+

Vcc:

Connector for internal voltage source (+ 5V) (a wiring bridge must be soldered on B11),
Never apply an external voltage across this pin.

GND:

Ground connection (only when a wiring bridge is soldered on B12).

3.3 Pin assignment of CN2

GND	68	□	□	34	Vcc
GND	67	□	□	33	Vcc
IN31-	66	□	□	32	IN31+
IN30-	65	□	□	31	IN30+
IN29-	64	□	□	30	IN29+
IN28-	63	□	□	29	IN28+
IN27-	62	□	□	28	IN27+
IN26-	61	□	□	27	IN26+
IN25-	60	□	□	26	IN25+
IN24-	59	□	□	25	IN24+
IN23-	58	□	□	24	IN23+
IN22-	57	□	□	23	IN22+
IN21-	56	□	□	22	IN21+
IN20-	55	□	□	21	IN20+
IN19-	54	□	□	20	IN19+
IN18-	53	□	□	19	IN18+
IN17-	52	□	□	18	IN17+
IN16-	51	□	□	17	IN16+
IN15-	50	□	□	16	IN15+
IN14-	49	□	□	15	IN14+
IN13-	48	□	□	14	IN13+
IN12-	47	□	□	13	IN12+
IN11-	46	□	□	12	IN11+
IN10-	45	□	□	11	IN10+
IN09-	44	□	□	10	IN09+
IN08-	43	□	□	9	IN08+
IN07-	42	□	□	8	IN07+
IN06-	41	□	□	7	IN06+
IN05-	40	□	□	6	IN05+
IN04-	39	□	□	5	IN04+
IN03-	38	□	□	4	IN03+
IN02-	37	□	□	3	IN02+
IN01-	36	□	□	2	IN01+
IN00-	35	□	□	1	IN00+

cc:

Connector for internal voltage source (+ 5V) (a wiring bridge must be soldered on B21),
Never apply an external voltage across this pin.

GND:

Ground connection (only when a wiring bridge is soldered on B22).

4. System Components

4.1 Block diagram

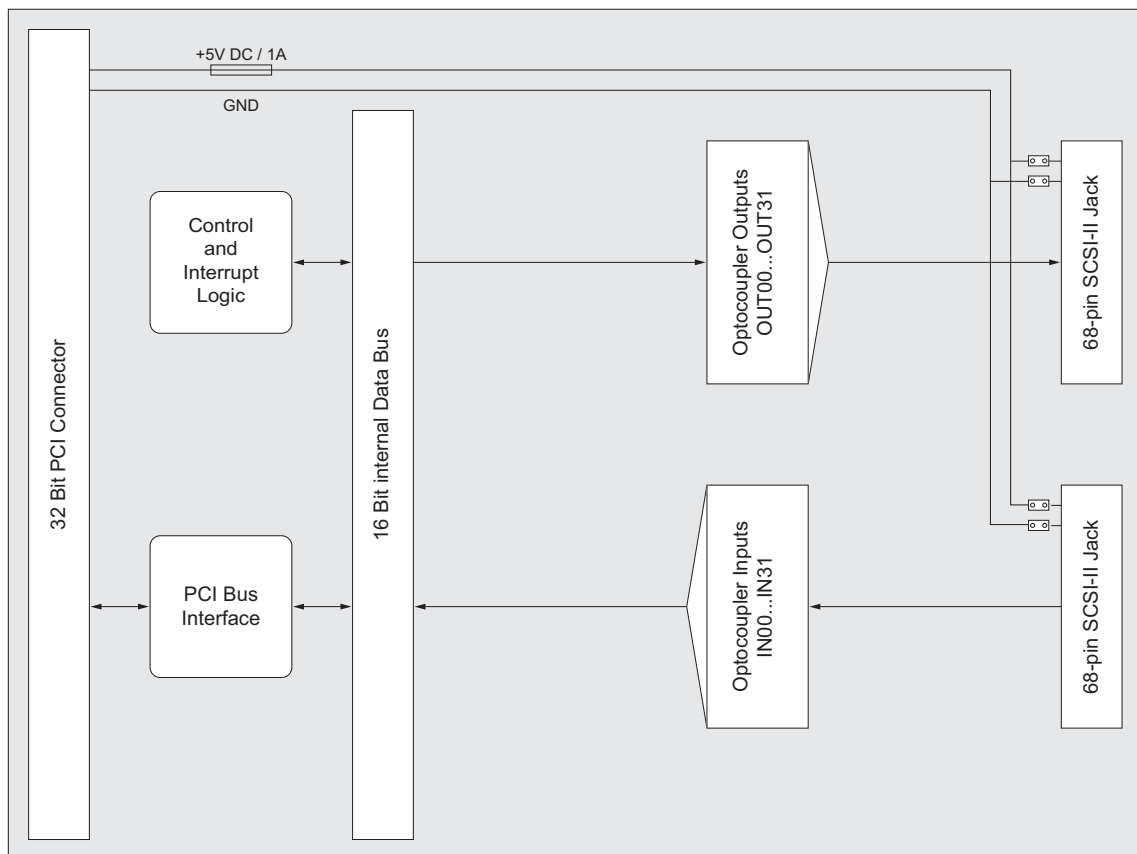

4.2 Access to the system components

Access to the hardware components of the OPTOIO-PCI32 is made by reading and writing in port addresses by support of library functions. The relevant addresses for OPTOIO-PCI32 depend on the base address given by the BIOS. You can access to the OPTOIO-PCI32 by word (16 Bit) access only. Access by double word or byte is not possible. (Please find more information in chapter Programming or in samples on the enclosed CD)

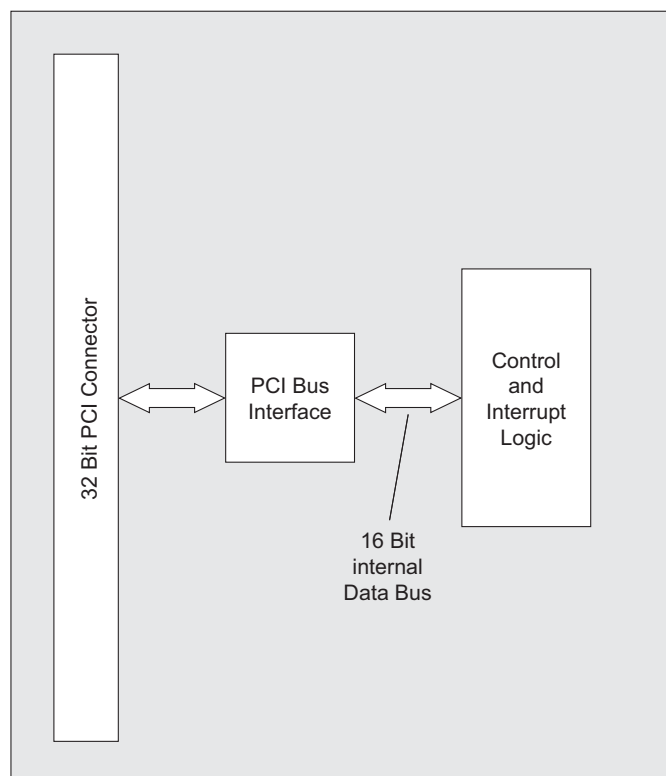

5. 32 Optocoupler Isolated Digital Inputs

Die OPTOIO-PCI32_{STANDARD} provides 32 input channels which are optical-ly isolated by optocouplers. The isolation voltage between the computer's ground and inputs is 500 Volt, whereas the voltage within the input channels is limited to 100 Volt.

5.1 Pin assignment of the input optocouplers

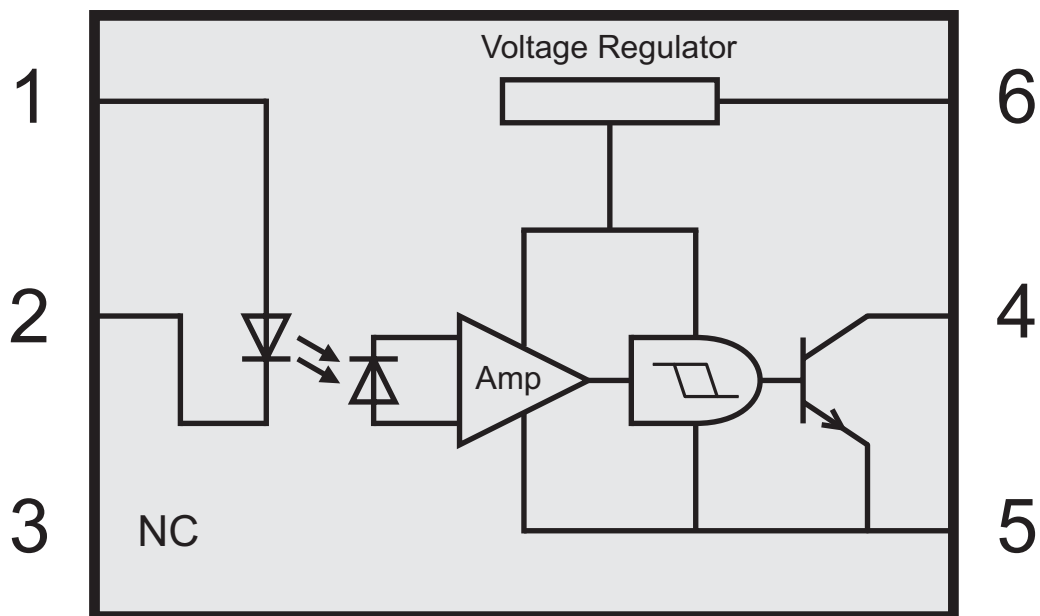

5.2 Input voltage ranges

You can select two input voltage ranges by exchange of the resistor arrays R1 through R4 of the OPTOIO-PCI32.

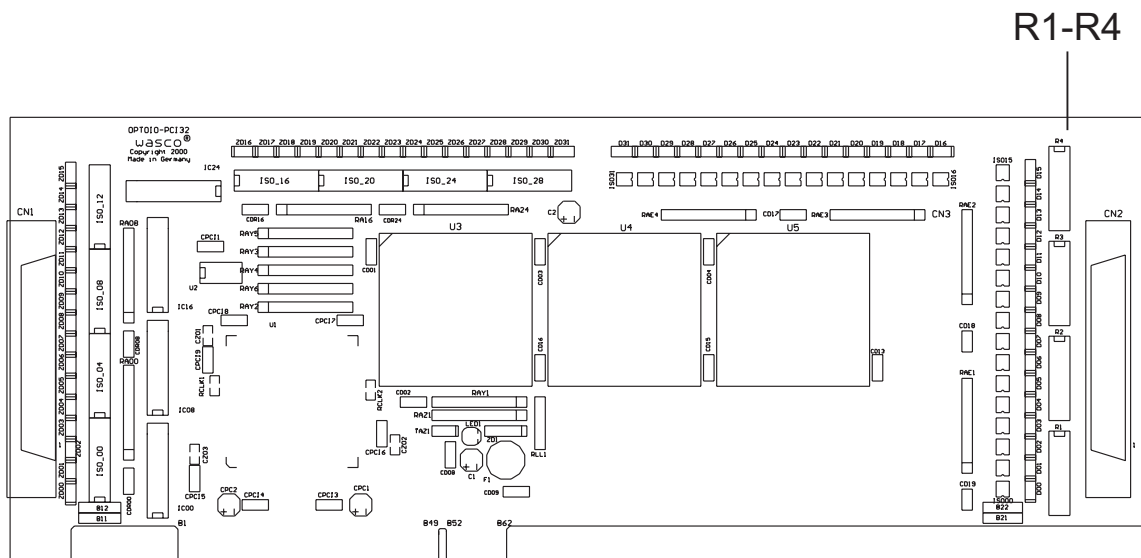

Please find the specifications of the two input voltage ranges in the table below:

Resistor Array R1-R4	Identifier	low	high
1,0 KOhm	102	0...1,5 V	2,2...15 V
4,7 KOhm	472	0...4,0 V	7,0...30 V

6. 32 Optically Isolated Outputs

Die OPTOIO-PCI32 provides 32 output channels, which are optically isolated by optocouplers. The isolation voltage between the computer's ground and outputs is 500 Volt.

6.1 Pin assignment of the output optocouplers

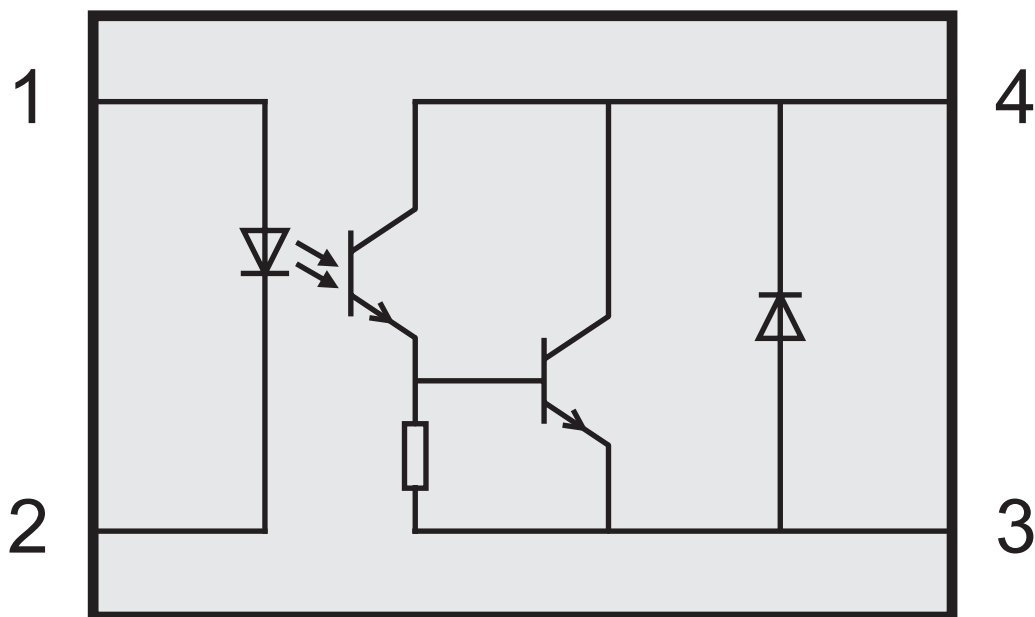

6.2 Optocoupler specifications

Voltage collector-emitter:	max. 50V
Voltage emitter-collector:	0,1V
Current collector-emitter:	150 mA

7. Programming under DOS[®]

7.1 Programming of the OPTOIO-PCI32

In the enclosed software you can find library functions and programming samples to access OPTOIO-PCI32 under DOS[®]. Hardware components are programmed by access to port addresses. These addresses depend on the I/O base address (and LC base address) issued by the PCI BIOS. Initializing routines can help to determine I/O base address, LC base address as well as the port addresses of each single hardware component. Additionally you can access to further information, such as IRQ number, the card's localisation in your bus system and the card version. If you work in a programming language not (yet) providing library functions, the program "OIO32SCA" (-> in directory UTIL) can help to determine the PCI parameters of OPTOIO-PCI32.

PCI Parameters:

- I/O Basic address
- IRQ Number
- LC Basic address
- Bus Number
- Device Number
- Number of function
- OPTOIO Version

PCI Identification:

Device-ID	=	\$9050
Vendor-ID	=	\$10B5
Subsystem-Vendor-ID	=	\$10B5
Subsystem-ID	=	\$1169

7.2 Allocation of the Port Addresses

The port addresses depend on the I/O base address (BA) and LC base address (LC) as follows:

Port/Register	BA + Offset	RD/WR
Optocoupler input port A (IN00...IN15)	BA + \$00	RD
Optocoupler input port B (IN16...IN31)	BA + \$02	RD
Optocoupler output port A (OUT00...OUT15)	BA + \$20	WR
Optocoupler output port B (OUT16...OUT31)	BA + \$22	WR

8. Windows® Programming

8.1 Programming of OPTOIO-PCI32

You have to install a special driver enabling port access to the card to apply the card under Windows®.

8.2 Installation of Windows® driver

To install the Windows® driver please run setup.exe in the directory „Treiber“ on the enclosed CD and then follow installation instructions.

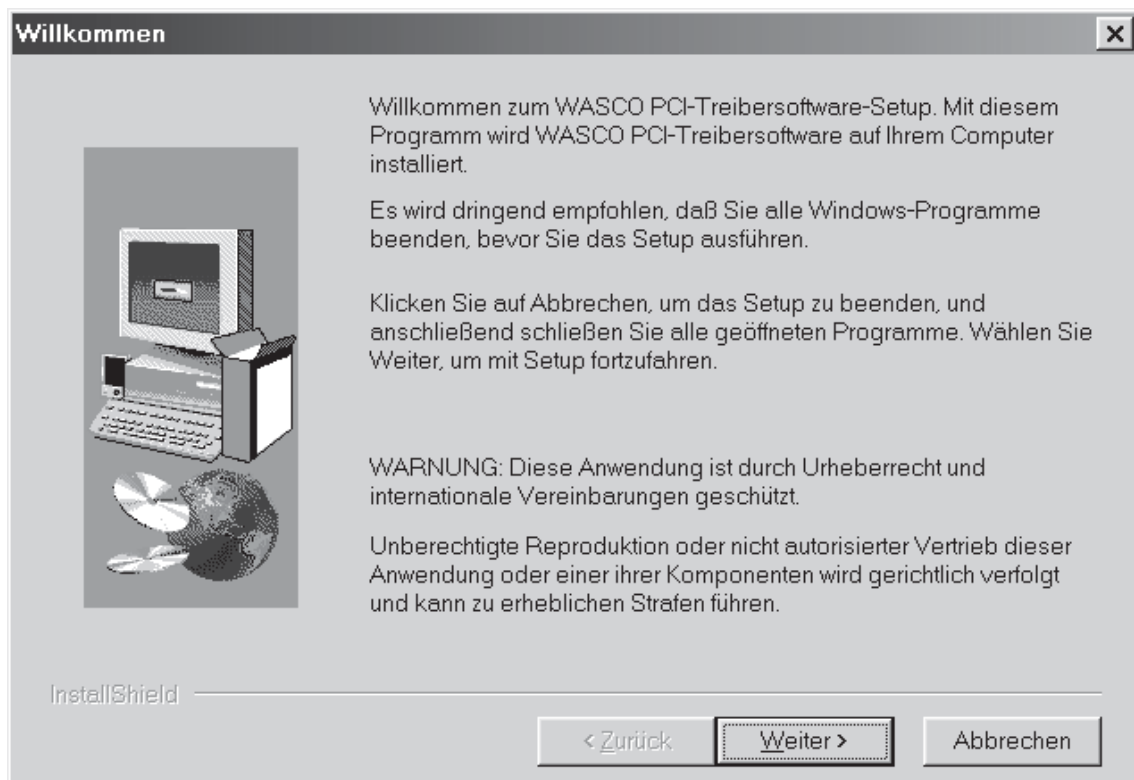

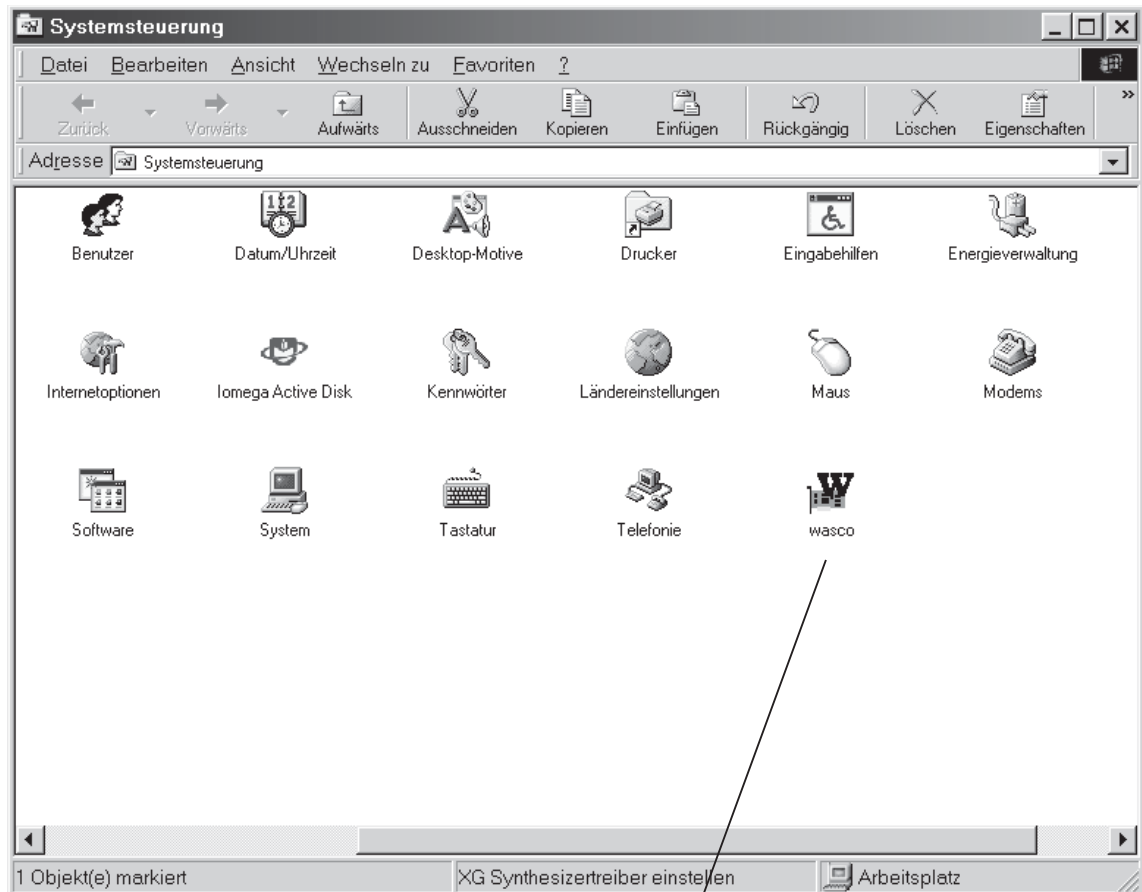

Having installed driver software completely, your system control panel shows an icon for the localisation of all **wasco**® PCI cards existing in the system.

Start the card's monitoring by double-clicking the "**wasco**®" icon. Following screen appears (in this example an OPTORE-PCI16 and an ADIODA-PCI12 may be used)

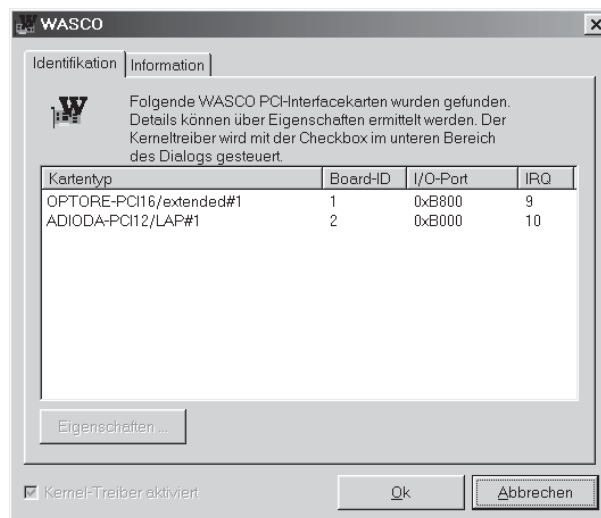

Once the system detected the card, this window shows card name, board ID, I/O address and possible interrupt number for each card. Furthermore the tab „Information“ leads to information about driver version and localisation of the driver file.



If the system did not detect your card, following error messages will pop up:

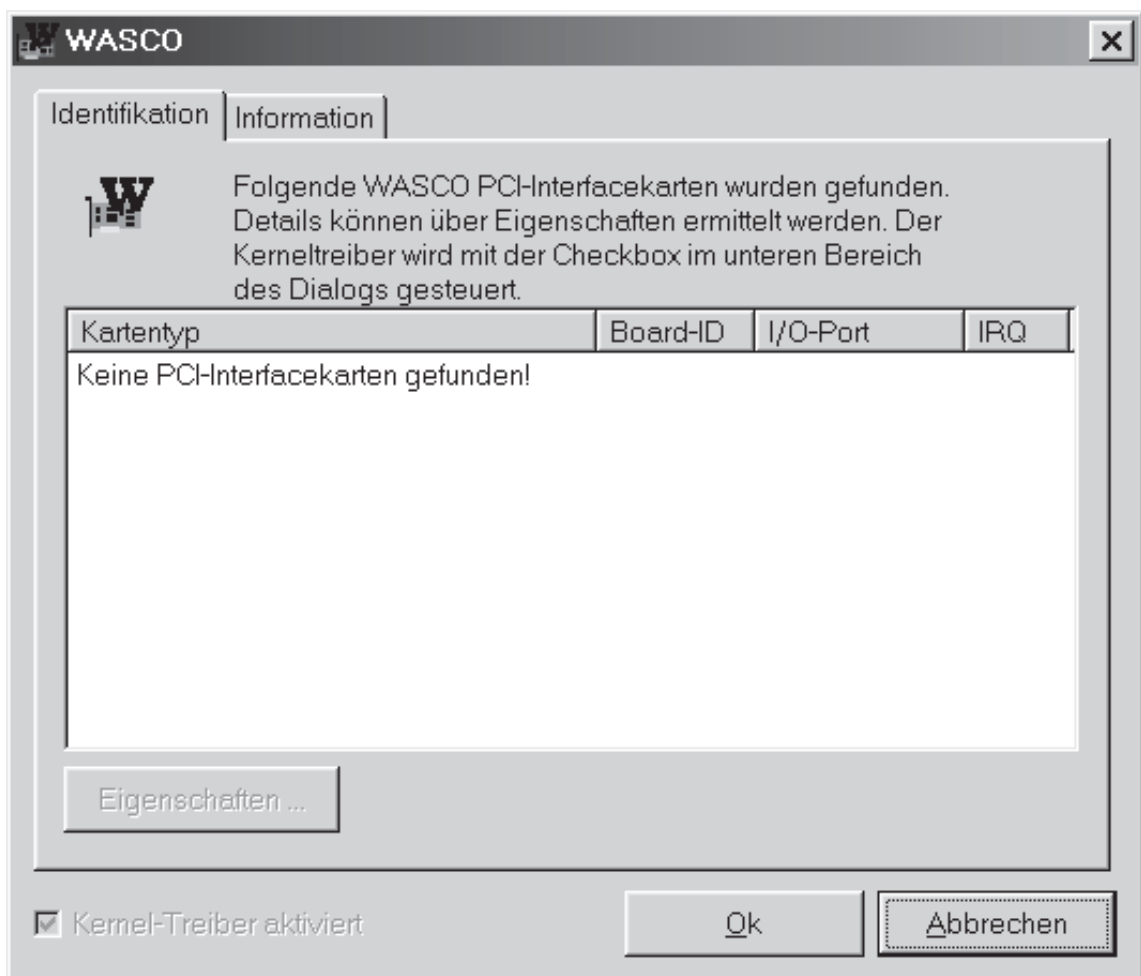
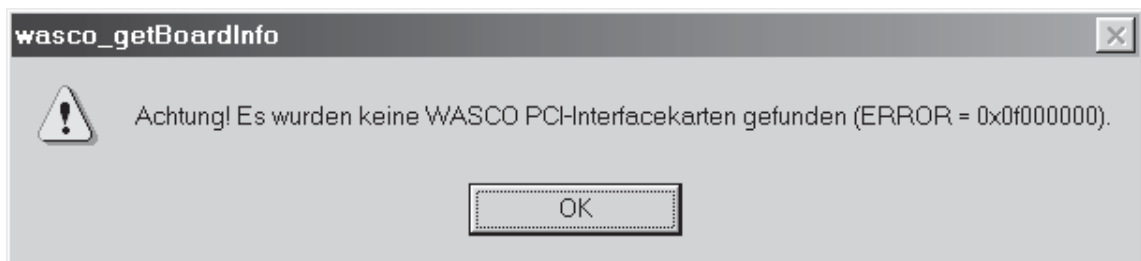

Please search for possible causes in chapter Troubleshooting.

9. Accessories

9.1 Compatible **wasco®** accessories

Connecting parts	EDP No.
PDB68F33DS68 Ribbon cable with slot bracket	A-498600
KMDB-68 Connecting Board	A-494800
DS68R100DS68 Connecting wire (1 meter)	A-492200
DS68R200DS68 Connecting wire (2 meters)	A-492400
DS68R500DS68 Connecting wire (5 meters)	A-492800

9.2 Connecting technique (application samples)

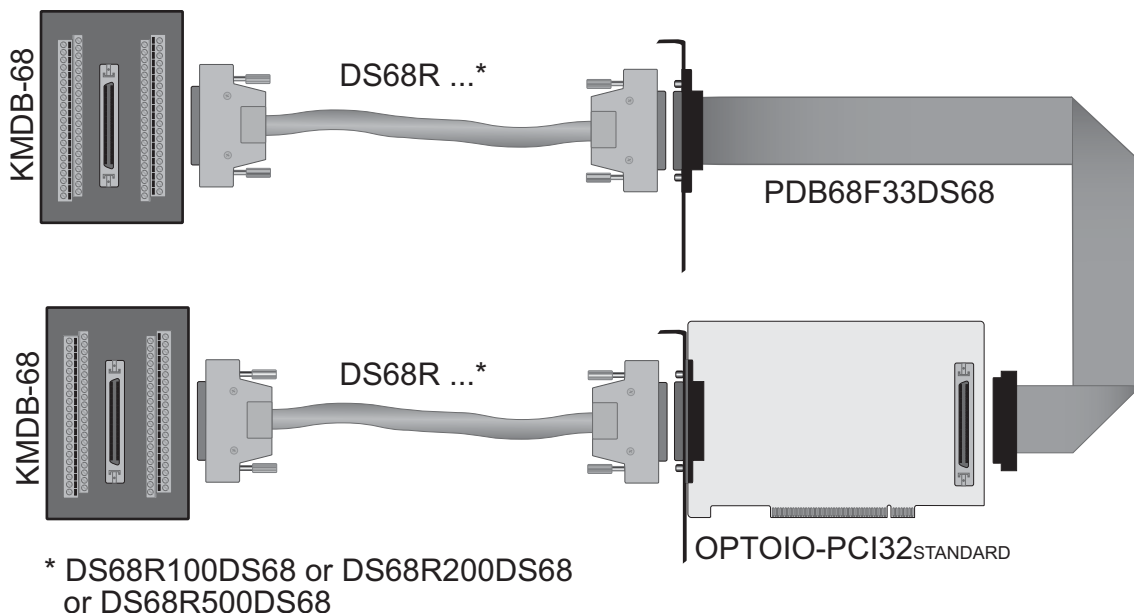

9.3 Single components for own assembly

Connection parts	EDP No.
SCSI-II plug 68pin for flat ribbon cable	A-553200
SCSI-II jack 68pin for flat ribbon cable	A-557200
Slot bracket with cutout for connector male/female 68 pin	A-577800
flat ribbon cable 68pin	A-572800

10. Troubleshooting

You can find below a short compilation of the most known error causes, which might occur while starting-up or running OPTOIO-PCI32.

Please check this list before you contact your dealer or distributor to solve your problem:

1. Is OPTOIO-PCI32 inserted to the PCI slot properly?
2. Are all cable connections alright?
3. Is the card's fuse (F1) blown?
4. Did your system detect the card correctly?
Please check all settings of your computer or contact your system administrator. (As this are BIOS settings we cannot expand on this issue. We point to your computer's system user's guide)
5. Did you install the latest driver version of the **wasco®** drivers?
Updates you can find here: <http://www.messcomp.com>
<http://www.wasco.de>

12. Product Liability Act

Information about Product Liability

The Product Liability Act (Act on Liability for Defective Products - Prod-HaftG) in Germany regulates the manufacturer's liability for damages caused by defective products.

The obligation to pay compensation can be given, if the product's presentation could cause a misconception of safety to a non-commercial end-user and also if the end-user is expected not to observe the necessary safety instructions handling this product.

It must therefore always be verifiable, that the non-commercial end-user was made familiar with the safety rules.

In the interest of safety, please always advise your non-commercial customer of the following safety instructions:

Safety instructions

The valid VDE instructions must be observed, when handling products that come in contact with electrical voltage.

Especially the following instructions must be observed:
VDE100; VDE0550/0551; VDE0700; VDE0711; VDE0860.

The instructions are available from:
Vde-Verlag GmbH
Bismarckstr. 33
10625 Berlin

- * unplug the power plug before you open the unit or make sure, there is no current to/in the unit.
- * You only may start up any components, boards or equipment, if they are installed inside a secure touch-protected casing before. During installation there must be no current to the equipment.
- * Make sure that the device is disconnected from the power supply before using any tools on any components, boards or equipment. Any electric charges stored in components in the device are to be discharged prior.
- * Voltaged cables or wires, which are connected with the unit, the components or the boards, must be tested for insulation defects or breaks. In case of any defect the device must be immediately taken out of operation until the defective cables are replaced.
- * When using components or boards you must strictly comply with the characteristic data for electrical sizes shown in the corresponding description
- * As a non-commercial end-user, if it is not clear whether or not the electrical characteristic data given in the provided description are valid for a component you must consult a specialist.

The compliance with building and safety instructions of all kinds (VDE, TÜV, industrial injuries corporation, etc.) are entirely the responsibility of the user/customer.

13. CE Confirmation

This is to certify, that the product

OPTOIO-PCI32^{STANDARD}
EDP Number A-440600

comply with the requirements of the relevant CE directives. This declaration will lose its validity, if the instructions given in this manual for the intended use of the products are not fully complied with.

EN 5502 Class B
IEC 801-2
IEC 801-3
IEC 801-4
EN 50082-1
EN 60555-2
EN 60555-3

The following manufacturer is responsible for this declaration:

Messcomp Datentechnik GmbH
Neudecker Str. 11
83512 Wasserburg

given by

Dipl.Ing.(FH) Hans Schnellhammer

Wasserburg, 30.05.2006



Reference system for intended use

This PC extension card not stand-alone device. The CE conformity only can be assessed when additional computer components are in use simultaneously. Thus the CE conformity only can be confirmed when using the following reference system for the intended use of the PC extension card:

Control Cabinet:	Vero IMRAK 3400	804-530061C 802-563424J 802-561589J
19" Casing:	Vero PC Casing	145-010108L
19" Casing:	Additional Electronic	519-112111C
Motherboard:	GA-586HX	PIV 1.55
Floppy Controller:	on Motherboard	
Floppy:	TEAC	FD-235HF
Graphic Card:	Advantech	PCA-6443
Interface:	OPTOIO-PCI32 _{STANDARD}	A-440600